

# Indoor Rowing School Curriculum



*A standards-based curriculum for fitness and fun  
through the lifelong sport of indoor rowing.*

**concept 2**  
INDOOR ROWER

800.245.5676 [concept2.com](http://concept2.com)



Created by Concept2 Employee Josh Carlson

Josh has been with Concept2 for 14 years. He came to Concept2 after completing a Bachelors Degree in Physical Education at Johnson State College in Vermont. For the past 10 years, Josh has coached nordic skiing ages K-12 and, most recently, also coaches youth soccer.

With thanks to Concept2, Ltd. for providing additional resources.

# TABLE OF CONTENTS

1. Introduction .....	2
2. About the Concept2 Indoor Rower	
Performance Monitor.....	4
Damper Setting and Workout Intensity .....	5
3. Setting up the Concept2 Indoor Rower for a Child.....	7
4. Keeping Kids Busy.....	8
Relay Rotation Strategies .....	9
5. Indoor Rowing Block Plans	
Block Plan for Grades 2-5 .....	10
Block Plan for Grades 6-8 .....	11
Block Plan for Grades 9-12 .....	12
6. Lesson Plans & Rubrics	
Lesson Plan #1 Introduction and Equipment .....	13
Lesson Plan #2 Technique .....	15
Lesson Plan #3 Stroke Rate and Intensity .....	17
Lesson Plan #4 Using the Performance Monitor .....	19
Lesson Plan #5 Setting up a Workout .....	21
Lesson Plan #6 Pace.....	23
Lesson Plan #7 Relay Races.....	25
Lesson Plan #8 2000 Meter Time Trial.....	27
Lesson Plan #9 Biomechanics of Rowing.....	29
Lesson Plan #10 Rowing & Heart Rate .....	31
7. Additional Resources	
Red, Yellow, Green .....	33
The Name Game.....	34
The Name Game Cards .....	35
The Weakest Link .....	36
Staying Alive .....	38
Frantic Relay .....	40
Indoor Rower Pace Chart.....	41
Proper Rowing Technique.....	42
Technique Review.....	43
Heart Rate Monitoring .....	44
Indoor Rower Layout .....	46
Row Together Program Statistical Analysis .....	47
Quick Facts .....	48
Biomechanics of Rowing .....	49
Muscle Groups .....	53
Anatomy of an Indoor Rower.....	61

# INTRODUCTION

Congratulations on deciding to include indoor rowing in your physical education class! In this book you will find lots of useful information on indoor rowing and lesson plans you can incorporate into your classes. Maybe you have Concept2 Indoor Rowers in your schools already but never realized the potential they have as a teaching tool. Maybe you are hearing about us for the first time. Either way, integrating indoor rowing into physical education is a wonderful way to challenge and motivate kids, have fun, and, most of all, get kids healthy and fit!

The approach taken in putting together this resource was one in which students and teachers are really taught about indoor rowing as a sport, the proper use and technique of rowing, and why rowing is an appropriate activity in teaching kids to be physically educated. The contents of this resource include handouts that you will find useful in teaching the lessons, assessment ideas, rubrics for each lesson, games that can be played as teaching tools, and many other indoor rowing tidbits to help you teach this wonderful exercise! Much of what you will find in this resource can also be found at [concept2.com](http://concept2.com).

The lesson plans are aligned with the **National Association for Sport and Physical Education (NASPE) Standards for Physical Education**.

**Standard 1** states that a physically educated student demonstrates competency in motor skills and movement patterns needed to perform a variety of physical activities.

Although the rowing stroke is not difficult, it is dynamic and rhythmic. Changes to the stroke can be made to produce different performance outcomes.

**Standard 2** states that a physically educated student demonstrates understanding of movement concepts, principles, strategies, and tactics as they apply to the learning and performance of physical activities.

The performance monitor on the indoor rower gives the student lots of useful feedback on performance. Rowing uses all of the major muscle groups through a wide range of motion. The indoor rower is the perfect piece of equipment to use as part of a personal fitness program.

**Standard 3** states that a physically educated student participates regularly in physical activity.

Indoor rowing is fun and challenging. Many schools and YMCAs run after-school programs using the indoor rowers. Some schools have formed rowing clubs and participate in team challenges. Rowing is also a great way to cross train for other sports and activities!

**Standard 4** states that a physically educated student achieves and maintains a health-enhancing level of physical fitness.

Indoor rowing is a great cardiovascular exercise. It can be both aerobic and anaerobic and with the heart rate monitoring function, students can see their progress. Assessing the student's fitness is very easy to do with the feedback the performance monitor provides and the use of logcards.

**Standard 5** states that a physically educated student exhibits responsible personal and social behavior that respects self and others in physical activity settings.

The sport of rowing requires a lot of team work! Relays are a great way to have the students pull together, coach each other on, and have a lot of fun while doing it.

**Standard 6** states that a physically educated student values physical activity for health, enjoyment, challenge, self expression, and/or social interaction.

Indoor rowing is not difficult to do but does offer a very challenging work out! Rowers are among the most fit athletes in the world. Rowing can be done for a lifetime for it is non-impact.

Here's why rowing is a great fit for kids and your school:

- The Concept2 Indoor Rower fits people of all sizes.
- The user controls the intensity of the exercise, so students can row as hard or as easily as is appropriate for them.
- The performance monitor provides simple but useful data that kids understand—distance, calories, time.
- Some kids will be much more successful with rowing than with other fitness options. For example, bigger heavier kids may dislike running, but they can often be very effective and successful at rowing. Kids with poor vision, or weak hand/eye coordination, may thrive on the indoor rower.
- The units of output can be easily adapted to classroom activities: meters convert to distance on a map for geography projects; watts relates to science class.
- Recent articles suggest that exercise can be an effective treatment for attention-deficit disorders, and rowing is one of the exercises that has helped some kids to focus better.
- The mechanics of the indoor rower itself are simple and easy for kids to grasp.
- The Concept2 online community is rich with resources including rowing challenges, logbooks, and rankings for kids and schools.
- The Fish Game allows kids to play on the performance monitor while also getting their exercise! You can download the Fish Game free from [concept2.com/fish](http://concept2.com/fish).
- In learning to row, kids are learning a sport which they can do for the rest of their lives.

• *And finally, kids seem to just like rowing!*

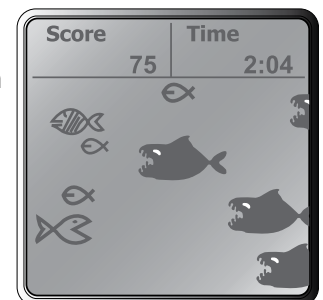

## ABOUT THE CONCEPT2 INDOOR ROWER

The Concept 2 Indoor Rower was first developed in 1981 as a means to continue rowing training through the winter even though all of the water was frozen. The original machine was a simple handle on a chain working an air resistance flywheel. In the last 26 years the indoor rower has gone through many changes, but the important parts are still essentially the same—the user still holds the handle which is attached to a chain and operates an air resistance flywheel. The differences are the technology and the design of the machine. The original, or Model A, was a simple bicycle wheel with blades attached to the spokes, and had a simple stroke counter. There are currently two versions, the Model D and the Model E, which have molded flywheel housings, and ergonomically designed seats and handles, and highly sophisticated electronic performance monitors (the PM3 and PM4).

The performance monitors are far removed from being simple meter counters. Some of the features are: five graphical display modes, easy programming and storage of workouts, a standard list of workouts, on-board video games, and online racing capabilities, depending on which monitor you have. Perhaps one of the most important features is that the times and distances are directly comparable between indoor rowers. This is unique to the Concept2 Indoor Rower and as a result it is the only piece of fitness equipment that has given rise to a totally new sport—Indoor Rowing with National, European and World Championships.



### PERFORMANCE MONITOR

A good training partner helps you stick with a program and reach your goals. We've designed the performance monitor (PM) to be the ideal, smart electronic training partner.

The PM is entirely menu-driven, so you don't have to remember any complicated button combinations. You can also "Just Row" without pushing any buttons at all.

We offer two choices of PMs, the PM3 or PM4. Here are some of the standard features:

- **Automatic Operation:** Just start to row and the monitor turns on and gives feedback. You don't have to push a single button.
- **Accurate tracking of performance data:** Distance, speed, pace, calories and watts.
- **Five display options:** All Data, Force Curve, Pace Boat, Bar Chart and Large Print.
- **LogCard:** Removable LogCard stores workout data and personal preferences. A LogCard is included with every PM.
- **USB Interface:** Transfer of data to PC or Mac.
- **Easy menu-driven operation:** Accesses a powerful list of features: preset workouts, save favorite workouts, row against a previous performance or pace boat, play the Fish Game, row with an animated rower to learn technique, review past workout results and choose from multiple language options.

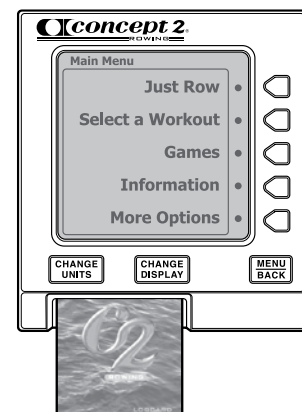

- **\*Heart Rate Monitoring:** Built in wireless compatibility with Suunto™ heart rate technology (chest belt provided), offers improved transmission and eliminates interference from nearby rowers. Also compatible with Polar™ heart rate technology, if optional Polar receiver is installed (available from Concept2).
- **\*Rechargeable Battery Pack:** As you row you will actually be recharging your battery. The battery pack can also be recharged by connecting the PM4 to a PC through the USB port.
- **\*Increased Memory Capacity:** To allow for future expansion and features
- **\*Supports Machine to Machine Racing:** Has the computing power to support both wireless and wired racing. No PCs needed. To learn more about the racing features and technical requirements visit [concept2.com/pm3](http://concept2.com/pm3).

**Note:** Features with an asterisk(\*) are found on the PM4 performance monitor only.

## DAMPER SETTING & WORKOUT INTENSITY

### Damper Setting

Resistance on the indoor rower is adjusted by means of a damper lever on the side of the flywheel. Offering a wide range of resistance, the damper lever increases or decreases the amount of air flow into the flywheel. The greater the airflow (damper setting 10), the greater the resistance and vice versa. Unfortunately some people confuse the damper settings with the value of the workout or their own fitness level. Here we try to dispel some of these misconceptions.

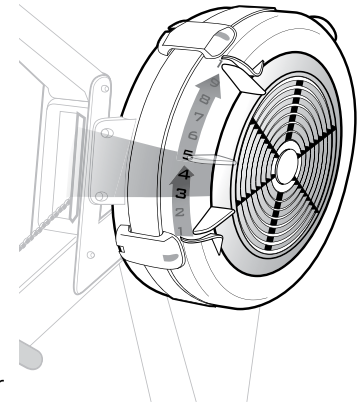

**Myth:** Rowing with more resistance will give a better workout.

**Fact:** The resistance setting is not a measure of your workout quality or quantity.

The settings 1-10 on the indoor rower are not work level settings or fitness level settings. The intensity of your workout is controlled by how hard you pull on the handle and is calculated and displayed by the electronic monitor as you row. Your accomplishment is indicated by the monitor, not the setting of the wind damper. As your fitness level and rowing skill improves you will be able to achieve better scores... i.e. faster pace, higher watt output, or greater rate of calorie consumption... regardless of the damper setting in which you choose to row. Think of the indoor rower as your boat. If you row at low intensity you can row for a long time. To make the boat go faster you pull harder; and if you try to make the boat go very fast you will be exhausted in a short time. Air resistance on the flywheel fan works just like the water resistance on a boat.

Now that you are thinking in terms of a boat on the water, let's examine the effect of the damper settings 1-10. In the lower numbers 1-4 the feel of the indoor rower is like a sleek racing shell. In the higher numbers 6-10 the feel is like a big, slow rowing boat. Either boat can be rowed hard; and as you try to make either boat go fast, you will need to apply more force. Making the sleek boat go fast requires you to apply your force more quickly; and when trying to make the big boat go fast you will feel a high force but at a slower speed of application.



**Q.** If I am exercising why don't I want to work at the highest force possible?

**A.** If you were weightlifting you would be interested in creating a high force to work against. However, indoor rowing is intended to be a cardiovascular workout lasting 20, 30 or more minutes. You should not be limited by muscular fatigue before your cardiovascular system is able to benefit. Rowing in a setting that results in too high a force can be detrimental to your training program by reducing your output, your enjoyment and the duration of your workouts. You should choose the setting in which you can achieve your best output score.

**Q.** Wouldn't I get my best score in the lowest setting ... the sleekest boat?

**A.** This would be true if the flywheel speed were taken directly as the speed of your "boat." However the electronic monitor is doing a lot of work while you exercise. As you are moving forward for your next stroke the monitor measures how much your flywheel is slowing down. It can determine precisely how sleek or slow your "boat" is by how much it slows down between strokes. It then uses this information to determine from the speed of the flywheel how much work you are doing. In this way your true effort is calculated regardless of damper setting.

### Workout Intensity

Here are some points to remember about workout intensity

- The harder you pull, the more resistance you will feel. This is because the Concept2 Indoor Rower uses wind resistance, which is generated by the spinning flywheel. The faster you get the wheel spinning, the more resistance there will be.
- You can row as hard or as easy as you wish. The indoor rower will not force you to row at any set intensity level. It is up to you. As you put more effort into your rowing, you will go faster, produce more watts, and burn more calories. All of these outputs will be measured and displayed by the performance monitor (PM). Keep your goals in mind. For example, if your goal is to burn a lot of calories, it is more important to row for a long time than to row hard. If you row too hard, you won't last as long.
- The damper setting is like bicycle gearing. It affects the feel of the rowing but does not directly affect the resistance. With a little experimentation, you will find the damper setting that gives you the best workout and results. We recommend a damper setting of 3-5 for the best aerobic workout. This is the setting that feels most like a sleek, fast boat on the water. Higher settings feel more like a bigger, slower boat.
- You can view your performance in pace, watts and calories. The PM displays your output in a choice of units and display options. You can choose the units and displays that work best for you.



# SETTING UP THE CONCEPT2 INDOOR ROWER FOR A CHILD

The Indoor Rower will fit people of all sizes with very few adjustments. Here are some basic recommendations:

**Damper Setting:** 1-3. If they say it feels too easy, remind them that they just have to pull harder and it will feel harder. Children should not row with a damper setting higher than 3. (Adults will get the best workout in a damper range of 3-5.)

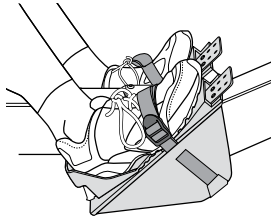
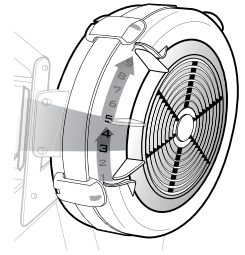

**Flexfoot:** Use the lowest setting (hole #1) for kids with the smallest feet. Very small feet may be even more comfortable with some foam placed below the heel. The goal is to have the footstrap crossing roughly over the ball of the foot.

## SAFETY:

- **Clothing:** Athletic shorts, tights or pants are recommended. Long shirt tails should be tucked in. **Baggy shorts and skirts should be avoided as they may get caught in the seat rollers.**
- **Keep fingers, pets and small children away from seat rollers.**
- **Do not let go of the handle!** Place it carefully either in handle hooks or against the flywheel.
- **Do not twist chain or pull from side to side.** Pull straight back with both hands.
- **Use proper technique at all times.** If you would like a copy of our free Technique DVD, please call or e-mail to request one.
- **Rowing hard:** When kids row hard and fast, they may get excited and forget about proper technique. This may cause them to slip off the seat! Be sure to practice rowing hard, building up to it gradually, so they learn proper control.

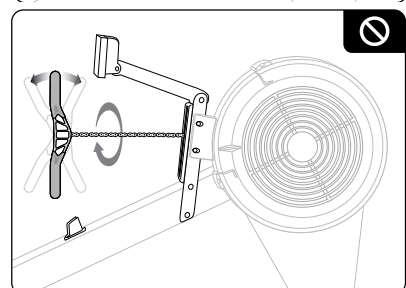
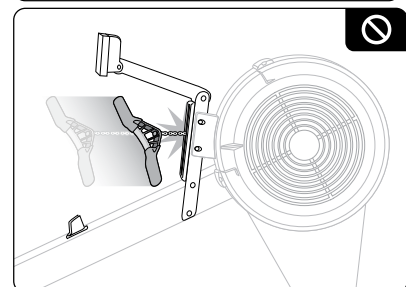
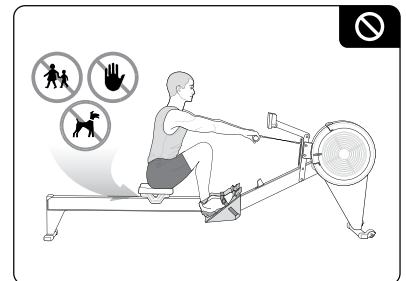
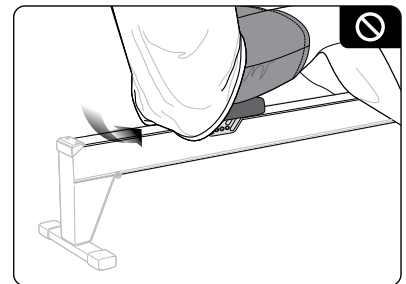

## KEEPING KIDS BUSY

You will find that your school probably has more kids than indoor rowers! Here are some things your students can do while they are waiting for their turn to row.

- Record meters rowed in their logbook. If they are rowing several short rows per day, they can spend some time doing the math of adding them up before they enter them in their logbook.
- Stretching and other exercises. Create a number of stations around the room: rowing, stretching, ab curls or ab bicycles, superman stretches (lying on your stomach), run a lap of the playground, jumping jacks. Put a sign at each station, and number them, and have the kids rotate whenever you call out – every minute perhaps.
- Plan a group “rowing” trip around/along a local body of water. Make a map to post with distance increments, and have the kids mark their progress along the route. When not rowing, kids can work on planning the trip, creating the map, and marking the progress.
- Use the indoor rower to keep kids on task while waiting a turn into a team game.
- Do research on the sport of rowing. How many different kinds of boats are raced in the Olympics? When was the first Olympics in which women rowed? What is a “head race” and how did it get that name? What is the difference between sweep rowing and sculling? Work on a presentation for the rest of the school.
- Fishing Derby: See link on schools page at [concept2.com](http://concept2.com) under keeping kids interested.
- If time and machine access is not an issue, then it will depend more on the individual students’ goals, level of conditioning, and attention span. The trick is to strike the right balance for each kids between fun and challenge. Some kids may have the head for longer steady rows, but interval workouts may do a better job of keeping kids focused and interested.



# Relay Rotation Strategies

## Time

Take your allotted program time and divide it roughly by the number of children you have in the group. For example, if you have one hour, two indoor rowers and 15 children, then each child gets a maximum of eight minutes of rowing. With start-up and transition time, it will probably be more like seven minutes. You can then decide if you want them to row their seven minutes non-stop, or split it into two or three different sittings. You can vary this from day to day. Be sure to have them record the number of meters they row each time for their logbooks!

## Number of Strokes

For variety, you can allot rowing time by number of strokes. Set up a rowing order for each machine, then have kids row a certain number of strokes, then switch. Thirty strokes should take about a minute. Be sure to have them record the number of meters they row each time for their logbooks!

## Distance

This is yet another way to allot rowing time. Keep in mind that it gives more time to the slower kids, because it takes them longer to cover the same distance. You might set any distance from 200 to 500 meters. Again, be sure to have them record the number of meters they row each time for their logbooks!

## Speedy Rotation

Kids will get into this! Try having each child row for 30 seconds, or 100 meters, or 15 strokes – then switch. This really minimizes the down time for everyone! However, you'll note that it makes it harder to keep track of how many meters each child has rowed—but it can be done. Assign kids to watch the PM and record the number meters as each child gets on and off. Then you'll have an opportunity for some math practice later as you calculate how far each child rowed!



## Indoor Rowing Block Plan Grades 2-5

1	2	3	4	5
<p><b>Introduction to Rowing</b></p> <p>History</p> <p>Rowing terminology</p> <p>Concept2 Indoor Rower</p> <p>Expectations</p> <p>Play "The Name Game"</p>	<p><b>Technique</b></p> <p>Show technique DVD</p> <p>Go over technique review sheet</p> <p>Students perform 4 stages of the rowing stroke</p> <p>Assess students on proper technique using technique check off sheet</p>	<p><b>Technique Review</b></p> <p>Play "The Weakest Link"</p> <p>Performance monitor: Show the different displays of units (calories, watts)</p> <p>Show how to use the logcards</p> <p>Row continuously 5-10 minutes</p>	<p><b>Review Performance Monitor &amp; Technique</b></p> <p>Workout: 10 minutes</p> <p>Set monitors for 10 minutes. Row in synchrony. While rowing, review technique (2 min.). Show differences in stroke rate and intensities.</p> <p>Show how intensity and stroke rate are not necessarily related (6 min)</p> <p>Technique drills (2 min)</p>	<p><b>Pre Assessment</b></p> <p>Review stroke rate and intensity</p> <p>4 minute test for meters</p> <p>Record meters rowed during test</p>
6	7	8	9	10
<p><b>Technique Review &amp; Monitor Set Up</b></p> <p>Discuss stroke rate and intensity</p> <p>Play "Staying Alive" using stroke rate</p>	<p><b>Stroke Rate and Intensity Review</b></p> <p>Discuss pace</p> <p>Play "Staying Alive"</p>	<p><b>Team Relay</b> <i>It is very important to do a warm-up before the relay!</i></p> <p>Break students into larger groups (8-12)</p> <p>Students row for shorter time with quick changes in between</p> <p>Students help each other on and off of indoor rower</p> <p>Record each team's meters</p> <p>Play the "Fish Game"</p>	<p><b>Biomechanics of Rowing</b></p> <p>Distribute Biomechanics of Rowing handout and discuss the musculature used during the stages of the rowing technique</p> <p>Row continuously for 10-15 minutes emphasizing a certain group of muscles and during a particular stage of rowing, ie. the "quadriceps" during the "drive"</p>	<p><b>4 Minute Test</b></p> <p>4 minute test for meters</p> <p>Record meters rowed during test</p> <p>Play the "Fish Game"</p>
11	12	13	14	15
<p><b>Heart Rate &amp; Rowing</b></p> <p>Discuss the effects of heart rate during rowing.</p> <p>Interval workout: 1 minute of work alternating with 1 minute of rest. Do 4 times and get heart rate after each minute of work</p>	<p><b>Rowing Review</b></p> <p>History/Quick facts</p> <p>Equipment</p> <p>Technique</p> <p>Rowing terms</p> <p>Performance monitor</p> <p>Biomechanics of rowing</p>	<p><b>Team Relay</b> <i>It is very important to do a warm-up before the relay!</i></p> <p>Break students into larger groups (8-12)</p> <p>Students row for shorter time with quick changes in-between</p> <p>Students help each other on and off of indoor rower</p> <p>Record each team's meters</p> <p>Play the "Fish Game"</p>	<p><b>5 Minutes of Easy Rowing Interval workout</b></p> <p>1 minute of work alternating with 1 minute of rest. Do 4 times and get heart rate after each minute of work</p>	<p><b>4 Minute Test</b></p> <p>4 minute test for meters</p> <p>Record meters rowed during test</p> <p>Play the "Fish Game"</p>

## Indoor Rowing Block Plan Grades 6-8

1	2	3	4	5
<b>Introduction to Rowing</b>  History Rowing terminology Concept2 Indoor Rower Expectations Anatomy of an Indoor Rower	<b>Technique</b>  Show technique DVD Go over technique review sheet Students perform 4 stages of the rowing stroke Assess students on proper technique using technique check off sheet	<b>Review Technique</b>  Play "The Weakest Link"  Row continuously for 10 minutes using proper technique	<b>Review Technique</b>  Introduce stroke rate and intensity	<b>5 Minutes of Easy Rowing</b>  Review of stroke rate and intensity Introduce setup of performance monitor Do a 4 minute assessment
6	7	8	9	10
<b>Review Monitor Setup</b>  Play "Staying Alive" using stroke rate 10 minutes of continuous rowing	<b>Warm up:</b> 2 minutes of easy rowing  <b>Intervals:</b> 4x500 meters with 1 minute rest (see workout menu on performance monitor)	<b>20 Minutes of Continuous Rowing</b>	<b>Heart Rate</b>  Have discussion of the effects of rowing and heart rate Have students calculate their aerobic and anaerobic training ranges Have students row while using the heart rate function and equipment  Play "Staying Alive"	<b>Team relay It is very important to do a warm-up before the relay!</b> Break students into larger groups (4-6) Students row for 1-2 minutes with quick changes in between Students help each other on and off of indoor rower Record each team's meters Play the "Fish Game"
11	12	13	14	15
<b>Review Setting up a Workout</b>  <b>Play "Fish Game"</b>  <b>Do Pyramid workout:</b> 1:00 work/ 1:00 rest 2:00 work/ 2:00 rest 3:00 work/ 2:00 rest 2:00 work/ 2:00 rest 1:00 work/ 1:00 rest	<b>Introduce Pace</b> 20 minutes of continuous rowing	<b>Warm up:</b> 2 minutes of easy rowing  <b>Intervals:</b> 4x500 meters with 1 minute rest (see workout menu on performance monitor)	<b>Games</b>  Play "Fish Game"  Play "Staying Alive" using pace	<b>2 minutes of easy rowing</b> <b>2000meter time trial</b> <b>Play "Fish Game"</b>
16	17	18	19	20
<b>Play "Fish Game"</b>  <b>Do Pyramid workout:</b> 1:00 work/ 1:00 rest 2:00 work/ 2:00 rest 3:00 work/ 2:00 rest 2:00 work/ 2:00 rest 1:00 work/ 1:00 rest	<b>Team Relay It is very important to do a warm-up before the relay!</b> Break students into larger groups (4-6) Students row for 1-2 min. with quick changes in between Students help each other on and off of indoor rower Record each teams meters	<b>Warm up:</b> 2 minutes of easy rowing  <b>Intervals:</b> 4x500 meters with 1 minute rest (see workout menu on performance monitor)	<b>Pace review</b>  <b>20 minutes of easy continuous rowing</b>	<b>2 minutes of easy rowing</b> <b>2000 meter time trial (final assessment)</b> <b>Play "Fish Game"</b>

## Indoor Rowing Block Plan Grades 9-12

1	2	3	4	5
<b>Introduction to Rowing</b>  History Rowing terminology Concept2 Indoor Rower Expectations Anatomy of an Indoor Rower	<b>Technique</b> Show technique DVD Go over technique review sheet Students perform 4 stages of the rowing stroke Assess students on proper technique using technique check off sheet	<b>Review Technique</b>  Play "The Weakest Link" Row continuously for 10 minutes using proper technique	<b>Review technique</b> <b>Introduce stroke rate and intensity</b>	<b>Do a 2000m time trial</b> (preassessment )  5 minutes of easy rowing  Review of stroke rate and intensity  Introduce setup of performance monitor
6	7	8	9	10
<b>Review monitor setup</b>  <b>Play "Staying Alive" using stroke rate</b>  Use pace or stroke rate <b>10 minutes of continuous rowing</b>	<b>Warm up:</b> 2 minutes of easy rowing  <b>Intervals:</b> 4x500 meters with 1 minute rest (see workout menu on performance monitor)	<b>Pace review</b>  <b>20 minutes of continuous rowing</b>	<b>Heart Rate</b>  Have discussion of the effects of rowing and heart rate Have students calculate their aerobic and anaerobic training ranges Have students row while using the heart rate function and equipment Play "Staying Alive"	<b>Team Relay</b> <b><i>It is very important to do a warm-up before the relay!</i></b> Break students into larger groups (4-6) Students row for 1-2 min. with quick changes in between Students help each other on and off of indoor rower Record each team's meters Play the "Fish Game"
11	12	13	14	15
<b>Review setting up a workout</b>  <b>Play "Fish Game"</b>  <b>Do Pyramid workout:</b> 1:00 work/ 1:00 rest 2:00 work/ 2:00 rest 3:00 work/ 2:00 rest 2:00 work/ 2:00 rest 1:00 work/ 1:00 rest	<b>20 minutes of continuous rowing</b>	<b>Warm up:</b> 2 minutes of easy rowing  <b>Workout:</b> Intervals 4x500 meters with 1:00 rest (see workout menu on performance monitor)	<b>Games</b>  Play "Fish Game"  Play "Staying Alive" use both stroke rate and intensity	<b>2 minutes of easy rowing</b>  <b>2000 meter time trial</b>  <b>Play "Fish Game"</b>
16	17	18	19	20
<b>Play "Fish Game"</b>  <b>Do Pyramid workout:</b> 1:00 work/ 1:00 rest 2:00 work/ 2:00 rest 3:00 work/ 2:00 rest 2:00 work/ 2:00 rest 1:00 work/ 1:00 rest	<b>Team Relay</b> <b><i>It is very important to do a warm-up before the relay!</i></b> Break students into larger groups (4-6) Students row for 1-2 minutes with quick changes in between Students help each other on and off of indoor rower Record each teams meters	<b>Warm up:</b> 2 minutes of easy rowing  <b>Intervals</b> 4x500 meters with 1 minute rest (see workout menu on performance monitor)	<b>Pace review</b>  <b>20 minutes of easy rowing</b>	<b>2 minutes of easy rowing</b>  <b>2000 meter time trial (final assessment)</b>  <b>Play "Fish Game"</b>

## Concept2 Indoor Rowing Lesson Plan #1: Introduction and Equipment

Purpose of the Lesson	Materials Needed
<p>To introduce students to the sport of indoor rowing and outline the parts and mechanics of the Concept2 Indoor Rower.</p>	<ul style="list-style-type: none"> <li>• Concept2 Indoor Rowers</li> <li>• Technique DVD</li> <li>• Indoor rower diagram</li> <li>• Rowing Quick Facts handout</li> <li>• The Name Game cards</li> </ul>

Expected Outcomes
<p><b>Grades 2-5:</b> Student will be able to identify indoor rowing as a sport and how it evolved from the type of rowing on the water that is done in international competition. Emphasis should be placed on knowing the major parts of the indoor rower (front end, monitor, flexfoot, monorail, and seat). Student will be aware of safety issues with using the indoor rower.</p> <p><b>Grades 6-8 and 9-12:</b> Student will be able to identify indoor rowing as a sport and how it evolved from the type of rowing on the water that is done in international competition. Emphasis should be placed on knowing the major parts of the indoor rower (front end, monitor, flexfoot, monorail, and seat). Student will be aware of safety issues with using the indoor rower and can properly adjust the foot stretchers to fit them. Students can recall some of the Rowing Quick facts.</p>

Procedure
<ol style="list-style-type: none"> <li>1. Have a brief discussion on the sport of rowing.</li> <li>2. Explain the sport's history and mention the rowing "quick facts."</li> <li>3. Hand out the diagram and introduce the Concept2 Indoor Rower. Show Concept2 Technique DVD - the section called Concept2 Indoor Rower.</li> <li>4. Show each component of the rower and give a description of the role of each component. Demonstrate how the indoor rower can easily be separated into two sections for storage.</li> <li>5. Go over the safety issues involved in using the indoor rower.</li> <li>6. Play the Name Game.</li> </ol>

Assessment Ideas
<ul style="list-style-type: none"> <li>• Teacher observes each student during the following procedures: attaching the monorail to front end, adjusting the foot stretchers and monitor arm and detaching the monorail from the front end. See checklist.</li> <li>• Students get into small groups and label the various parts of the indoor rower using the Name Game cards while assessing each other.</li> </ul>



## Rubric #1: Equipment

Intro/ Equipment	1	2	3	4
<b>Sport of rowing</b>	Does not recognize indoor rowing as a sport and cannot recall any quick facts	Identifies indoor rowing as a sport and can recall some of the quick facts with assistance	Identifies indoor rowing as a sport and can recall some of the quick facts	Identifies indoor rowing as a sport, can recall all of the quick facts, and makes the relationship with on water rowing
<b>Parts of an indoor rower</b>	Cannot label/name any of the parts of the indoor rower with assistance	Can label/name most of the parts of the indoor rower with assistance	Can label/name most of the parts of the indoor rower on own	Can label/name all the parts of the indoor rower on own
<b>Safety/maintenance</b>	Cannot operate the indoor rower safely and has no regard for maintenance	Can operate the indoor rower safely and perform simple maintenance in a group with assistance	Can operate the indoor rower safely and perform simple maintenance in a group	Can operate the indoor rower safely and perform simple maintenance on own

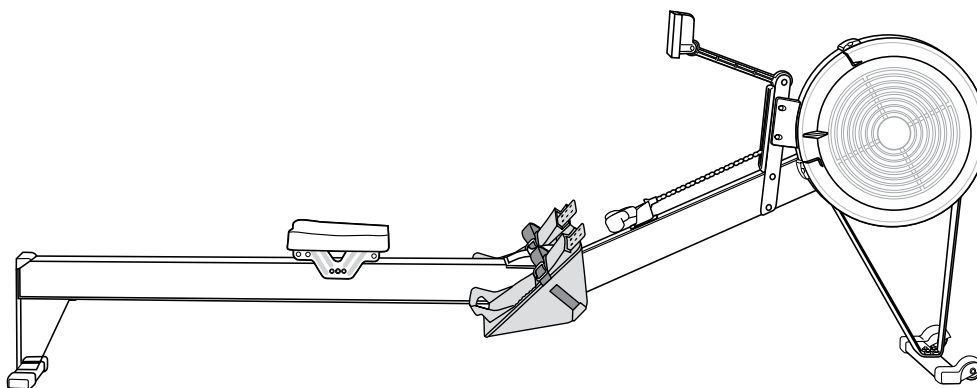

## Concept2 Indoor Rowing Lesson Plan #2: Technique

Purpose of the Lesson	Materials Needed
<p>To introduce rowing technique and break down its components.  <b>NASPE Standard 1:</b> Demonstrates competency in motor skills and movement patterns needed to perform a variety of physical activities.</p>	<ul style="list-style-type: none"> <li>• Concept2 Indoor Rowers</li> <li>• Technique DVD</li> <li>• Technique review handout and checklist</li> </ul>

### Expected Outcomes

#### Grades 2-5:

Student knows the five stages of rowing technique and executes each stage with proper form. Student demonstrates the four stages as a continuous and blended motion. Student knows what it means to "over compress" at the "catch" and what excessive "layback" is at the "finish."

#### Grades 6-8:

Student knows the five stages of the rowing technique and executes each stage with proper form. Student demonstrates the five stages as a continuous and blended motion. Student can identify two technique faults. Student knows what it means to "over compress" at the "catch" and what excessive "layback" is at the "finish." Student can row continuously with proper technique for five minutes.

#### Grades 9-12:

Student knows the five stages of the rowing technique and executes each stage with proper form. Student demonstrates the five stages as a continuous and blended motion. Student knows what it means to "over compress" at the "catch" and what excessive "layback" is at the "finish." Student can identify four technique faults. Student can row continuously with proper technique for 10 minutes.

### Procedure

1. Show Concept2 Technique DVD—the section called Stroke Development and Correction.
2. Go over technique review sheet and have discussion on the five stages of proper rowing technique and the technique faults.
3. Teacher or student demonstrates the five stages of technique for class on indoor rower.
4. Each student demonstrates and practices proper technique on indoor rower for a period of time (5-10 minutes).

### Assessment Ideas

- Teacher refers to technique review sheet while student demonstrates proper rowing technique.
- Self assessment: Students separate into small groups and assess each other while referring to the technique review check list.
- Match each technique stage with a correct description of the stage,(i.e., pull handle all the way to the abdomen, straighten legs, lean upper body back slightly = Finish).

## Rubric #2: Technique

Technique	1	2	3	4
<b>Catch</b>	Performed incorrectly throughout	Meets 2 out of 3 criteria for proper technique during the "catch"	<ol style="list-style-type: none"> <li>1. Draws body forward until the shins are vertical</li> <li>2. Upper body leaning forward at the hips</li> <li>3. Arms fully extended</li> </ol>	<p>Demonstrated the "catch" correctly and continuously for:</p> <p>5 min. grades 6-8</p> <p>10 min. grades 9-12</p>
<b>Drive</b>	Performed incorrectly throughout	Meets 2 out of 3 criteria for proper technique during the "drive"	<ol style="list-style-type: none"> <li>1. Begins the drive by pressing down the legs</li> <li>2. Keeps arms straight and holds back firm to transfer leg power up to the handle</li> <li>3. Gradually swings back with upper body, bends arms and presses against the legs until reaching a slight backward lean at the finish</li> </ol>	<p>Demonstrated the "drive" correctly and continuously for:</p> <p>5 min. grades 6-8</p> <p>10 min. grades 9-12</p>
<b>Finish</b>	Performed incorrectly throughout	Meets 2 out of 3 criteria for proper technique during the "finish"	<ol style="list-style-type: none"> <li>1. Straightens legs</li> <li>2. Pulls handle all the way into abdomen</li> <li>3. Leans upper body back slightly</li> </ol>	<p>Demonstrated the "finish" correctly and continuously for:</p> <p>5 min. grades 6-8</p> <p>10 min. grades 9-12</p>
<b>Recovery</b>	Performed incorrectly throughout	Meets 3 out of 4 criteria for proper technique during the "recovery"	<ol style="list-style-type: none"> <li>1. Extends arms toward the flywheel</li> <li>2. Leans upper body forward at the hips to follow the arms</li> <li>3. Arms are extended before knees are bent</li> <li>4. Gradually bends legs to slide forward on the seat</li> </ol>	<p>Demonstrated the "recovery" correctly and continuously for:</p> <p>5 min. grades 6-8</p> <p>10 min. grades 9-12</p>

## Concept2 Indoor Rowing Lesson Plan #3: Stroke Rate and Intensity

Purpose of the Lesson	Materials Needed
<p>To teach students the difference between stroke rate and intensity and how the two are not necessarily related.</p> <p><b>NASPE Standard 2:</b> Demonstrates understanding of movement concepts, principles, strategies, and tactics as they apply to the learning and performance of physical activity.</p>	<ul style="list-style-type: none"> <li>• Concept2 Indoor Rowers</li> <li>• Pace Chart</li> <li>• Red and white flags (if playing <i>Staying Alive</i> game)</li> </ul>

Expected Outcomes
<p><b>Grades 2-5:</b> Student will demonstrate proper rowing technique. Student will recognize the difference between a high stroke rate and a low stroke rate. Student will perform a workout experimenting with changing intensities. Emphasis should be placed less on stroke rates and more on the difference between rowing at a high intensity and a low intensity.</p> <p><b>Grades 6-8:</b> Student will demonstrate proper rowing technique. Student will recognize the relationship between stroke rate and intensity. Student will know where to view stroke rate on the Performance Monitor. Student will demonstrate rowing with changing stroke rates and be able to “feel” the changes in intensity.</p> <p><b>Grades 9-12:</b> Student will demonstrate proper rowing technique. Student will recognize the relationship between stroke rate and intensity. Student will know where to view stroke rate on the Performance Monitor. Student will demonstrate rowing with changing stroke rates and be able to “feel” the changes in intensity as well as see the changes reflected in the PACE display of the Performance Monitor.</p>

Procedure
<ol style="list-style-type: none"> <li>1. Have a review and demonstration on proper rowing technique.</li> <li>2. Discuss how Stroke Rate (spm= strokes per min.) is the cadence of the rowing stroke. Emphasize how the person rowing changes the intensity by pushing harder with the legs and not by using a faster stroke rate!</li> <li>3. Perform a rowing piece that uses different stroke rates and intensities.</li> <li>4. Warm up with 1 minute of easy rowing then do the following rowing piece: <ul style="list-style-type: none"> <li>• 1 minute @26 spm, comfortable effort, 30 second rest.</li> <li>• 1 minute @26 spm, harder effort, 30 second rest.</li> <li>• 1 minute @20 spm, comfortable effort, 30 second rest.</li> <li>• 1 minute @20 spm, harder effort, 30 second rest.</li> <li>• End with 1 minute of easy rowing.</li> </ul> </li> </ol>

Assessment Ideas
<ul style="list-style-type: none"> <li>• If playing <i>Staying Alive</i> (see section on games), see how long students stay in the game.</li> <li>• Have students watch each other and make corrections on technique and stroke rate as needed.</li> </ul>

## Rubric #3: Stroke Rate and Intensity

1	2	3	4
<ul style="list-style-type: none"> <li>• Uses some proper technique</li> <li>• Inconsistent stroke rate and intensity</li> </ul>	<ul style="list-style-type: none"> <li>• Uses proper technique</li> <li>• Consistent stroke rate but inconsistent intensity</li> </ul>	<ul style="list-style-type: none"> <li>• Uses proper technique</li> <li>• Can view stroke rate on the performance monitor</li> <li>• Keeps a consistent stroke rate</li> <li>• Can change intensity without changing stroke rate</li> <li>• Can change stroke rate without changing intensity</li> </ul>	<ul style="list-style-type: none"> <li>• Uses proper technique</li> <li>• Can view stroke rate on the performance monitor</li> <li>• Keeps a consistent stroke rate</li> <li>• Can change intensity without changing stroke rate</li> <li>• Can change stroke rate without changing intensity and....</li> <li>• Can verbally identify the difference between stroke rate and intensity</li> </ul>



## Concept2 Indoor Rowing Lesson Plan #4: Using the Performance Monitor

Purpose of the Lesson	Materials Needed
<p>To teach students how to use the different functions of the Performance Monitor.</p> <p><b>NASPE Standard 2:</b> Demonstrates understanding of movement concepts, principles, strategies, and tactics as they apply to the learning and performance of physical activity.</p>	<ul style="list-style-type: none"> <li>• Concept2 Indoor Rowers</li> <li>• LogCards</li> </ul>

Expected Outcomes
<p><b>Grades 2-5:</b> Keep it basic. Student should be able to navigate through the performance monitor menu and select the options for Just Row and the Fish Game. Student should be able to change the monitor displays and units of measure. The student should be able to view the time spent rowing and the meters covered while rowing.</p> <p><b>Grades 6-8:</b> Emphasis should be placed on navigating through the performance monitor menu to select a workout from the Standard Workout list. Student will be able to set up a user name on a LogCard. Student should be able to change the monitor displays and units of measure. Student should be able to view the time spent rowing and the meters covered while rowing. Student should be able to identify where time, stroke rate, pace, meters rowed and average pace are viewed on the performance monitor.</p> <p><b>Grades 9-12:</b> Emphasis should be placed on navigating through the menu to select from the Workout list. Student will be able to set up a user name on a LogCard and be able to recall workout data from the LogCard. Student will be able to select a workout from the Custom Workout list. Student should be able to identify where pace, stroke rate, time, and average pace are viewed on the performance monitor.</p>

Procedure
<ol style="list-style-type: none"> <li>1. Hand out LogCards and describe the information that can be stored on the cards. If there are not enough LogCards for each student, demonstrate with the teacher's card.</li> <li>2. Have students set up as a user on the LogCards.</li> <li>3. Demonstrate how to turn on the performance monitor and navigate to the Just Row display.</li> <li>4. In the Just Row display, point out the different windows where time, stroke rate, pace, meters rowed and average pace can be viewed.</li> <li>5. Demonstrate how to return to the Main Menu and get to the Workout display.</li> <li>6. From the Workout display, have students practice entering workouts from the Standard Workout list and the Custom Workout list.</li> <li>7. If time allows have the students select a workout and row the selected piece.</li> </ol>

Assessment Ideas
<ul style="list-style-type: none"> <li>• Student records and stores the workout in his or her personal log.</li> <li>• Students design a workout together and perform it as a group.</li> <li>• Student analyzes the data (calories burned, heart rate zones, work done. etc.) from the workout.</li> </ul>

## Rubric #4: Using the Performance Monitor

Performance Monitor	1	2	3	4
<b>Changes Displays</b>	Cannot change the monitor display to switch units of measure with assistance	Changes the monitor display to switch units of measure with assistance	Changes the monitor display to switch units of measure on own	Changes the monitor display to switch units of measure on own and identifies the various units of measure
<b>Identifies with different panes in display</b>	Cannot identify which window panes display stroke rate, time, meters, and pace with assistance	Identifies which window panes display stroke rate, time, meters, and pace with assistance	Identifies which window panes display stroke rate, time, meters, and pace	Identifies which window panes display stroke rate, time, meters, pace, and average pace
<b>Choosing workout</b>	Cannot navigate to select from the standard workouts menu	Navigates to select from the standard workouts menu with assistance	Navigates to select from the standard workouts menu	Navigates to workout menu and can create a new workout
<b>Logcard</b>	Unable to set up as a logcard user with assistance	Able to set up as a logcard user with assistance	Able to set up as a logcard user	Able to set up as a logcard user with assistance and can add multiple users on the logcard



## Concept2 Indoor Rowing Lesson Plan #5: Setting up a Workout

Purpose of the Lesson	Materials Needed
<p>To teach the student to design their own program that is challenging and enjoyable in order to achieve a health-related level of fitness.</p> <p><b>NASPE Standard 4:</b> Achieves and maintains a health-enhancing level of physical fitness.</p>	<ul style="list-style-type: none"> <li>• Concept2 Indoor Rowers</li> <li>• LogCards</li> </ul>

Expected Outcomes
<p><b>Grades 2-5:</b> Keep it basic. Students should be able to navigate the Performance Monitor and select a workout from the Standard Workouts list. The student should recognize the difference between a preset time workout and a preset distance workout. The student should be able to view the time spent rowing and the meters accumulated while rowing.</p> <p><b>Grades 6-8:</b> Emphasis should be placed on navigating through the menu and select a workout from the Custom Workouts list. The student should be able to identify where pace, stroke rate, time, and average pace are viewed on the Performance Monitor. Student will be able to save the workout on a LogCard.</p> <p><b>Grades 9-12:</b> Emphasis should be placed on navigating through the menu and select a workout from the New Workout list. Student will be able to create a custom workout from the New Workout screen that shows a variety. The student should be able to identify where pace, stroke rate, time, and average pace are viewed on the Performance Monitor. Student will be able to save a workout as a "Favorite" on a LogCard and recall the workout data from the LogCard.</p>

Procedure
<ol style="list-style-type: none"> <li>1. Have a discussion on the different types of workouts that can be performed on the indoor rower.</li> <li>2. Give the students a specific amount of time to complete a workout (15-20 minutes is recommended). Students save the workout as a "Favorite" if using LogCards.</li> <li>3. The class will set up a custom workout that will include a warm up, the workout and a cool down.</li> <li>4. Have the students do the workout and recall the data on the LogCard.</li> </ol>

Assessment Ideas
<ul style="list-style-type: none"> <li>• Students design a workout together and perform it as a group.</li> <li>• Student analyzes the data (calories burned, heart rate zones, work done) from the workout.</li> <li>• Student enters the workout into the Concept2 online logbook.</li> </ul>

## Rubric #5: Setting up a Workout

<b>20 points</b>	_____ can operate the Performance Monitor
<b>20 points</b>	_____ can identify different types of workouts: <ul style="list-style-type: none"><li>• Interval</li><li>• Pyramid</li><li>• Variable Interval</li></ul>
<b>20 points</b>	_____ sets up a workout on monitor that can be done during class time
<b>20 points</b>	_____ performed the workout
<b>20 points</b>	_____ performed workout using proper technique



## Concept2 Indoor Rowing Lesson Plan #6: Pace

Purpose of the Lesson	Materials Needed
<p>The purpose of this lesson is for the student to understand and feel the relationship between pace and intensity</p> <p><b>NASPE Standard 2:</b> Demonstrates understanding of movement concepts, principles, strategies, and tactics as they apply to the learning and performance of physical activities.</p>	<ul style="list-style-type: none"> <li>• Concept2 Indoor Rowers</li> <li>• Pace Chart</li> <li>• Colored tape</li> <li>• Pencils and paper</li> </ul>
<h3 style="text-align: center;">Expected Outcomes</h3>	
<p><b>Grades 2-5:</b> Emphasis should be placed more on stroke rate rather than pace. Show where pace is displayed on the performance monitor and how pace can change or stay consistent with each stroke.</p> <p><b>Grades 6-8:</b> Emphasis should be placed on the ability to pick a desired pace range and stay in that range for a period of time, i.e., a 2:05-2:15 pace for 5 to 10 minutes. The pace should vary only by +/- 10 seconds with each stroke.</p> <p><b>Grades 9-12:</b> Emphasis should be placed on the ability to pick a desired pace range and stay in that range for a period of time, i.e., a 2:05-2:10 pace for 10 to 15 minutes. The pace should vary only by +/- 5 seconds with each stroke. Introduce the “projected meters/time” function on the performance monitor.</p>	
<h3 style="text-align: center;">Procedure</h3>	
<ol style="list-style-type: none"> <li>1. Distribute the indoor rowing pace chart.</li> <li>2. Have a discussion on the relationship between pace and intensity. The lower the pace time, the more intense the rowing.</li> <li>3. Using the pace chart, show how pace, time, and distance are related and achieved.</li> <li>4. On the Performance Monitor, point out where the user can see their predicted time or distance over a preset distance or time.</li> </ol> <p>Optional activity:</p> <ol style="list-style-type: none"> <li>1. Have the students choose a pace that is comfortable to moderate and record the pace..</li> <li>2. On the performance monitor, preset a distance of 500-1000 meters, depending on class size (choose a monitor display that does not show average pace, the predicted time, or the predicted distance). Place a piece of colored tape over the pace window of the performance monitor.</li> <li>3. Have the student try to row their chosen pace for the duration of the preset distance without seeing it on the monitor.</li> </ol>	
<h3 style="text-align: center;">Assessment Ideas</h3>	
<ul style="list-style-type: none"> <li>• Teacher sees how closely the student’s average pace compares to the pace they chose.</li> <li>• Students get in pairs and coach the “rower” on achieving the desired pace. (Flip the monitor over so the student rowing cannot see it).</li> <li>• Play Staying Alive using pace instead of stroke rate.</li> <li>• Student records the result in a log and refers to it for improvements.</li> <li>• Repeat the procedure using a preset time instead of preset distance and compare the results.</li> </ul>	

## Rubric #6: Pace

<b>Pace</b>	<b>1</b>	<b>2</b>	<b>3</b>	<b>4</b>
<b>Monitor</b>	Unable to set monitor with assistance	Set monitor with assistance	Set within 2 minutes	Set in less than 2 minutes
<b>Technique</b>	Used improper technique throughout entire time	Used proper technique 50% of the time	Used proper technique 75% of the time	Used proper technique throughout entire time
<b>Pace Chart</b>	Unable to use pace chart with assistance	Used pace chart with assistance	Used pace chart correctly	Used pace chart correctly
<b>Relationship pace, intensity, distance</b>	Matched pace within +/- 20 seconds	Matched pace within +/- 15 seconds	Matched pace within +/- 10 seconds	Matched pace within +/- 5 seconds
<b>Sensory</b>	Did not feel pace rowed was close to accurate	Felt pace rowed was close to accurate	Felt pace rowed was accurate	Felt pace rowed was accurate and was done at a high intensity

## Concept2 Indoor Rowing Lesson Plan #7: Relay Races

Purpose of the Lesson	Materials Needed
To have fun and show teamwork while rowing. <b>NASPE Standard 5:</b> Exhibits responsible personal and social behavior that respects self and others in physical activity settings.	<ul style="list-style-type: none"><li>• Concept2 Indoor Rowers</li><li>• Computer with venue racing software (optional)</li></ul>

Expected Outcomes
<p><b>Grades 2-5:</b> Use a fixed time rather than a fixed distance. Emphasis should be placed on students rowing at short intervals. A strategy of counting number of strokes could be used instead of time or distance per student. Students will cheer and shout words of encouragement during the relay.</p> <p><b>Grades 6-8:</b> Emphasis should be placed on using proper technique throughout the relay. Choose distances or times that are longer in length than the 2-5 grade level. Students will cheer and shout words of encouragement during the relay.</p> <p><b>Grades 9-12:</b> Emphasis should be placed on using proper technique throughout the relay. Choose rowing pieces that are both a fixed time and a fixed distance. Students will cheer and shout words of encouragement during the relay.</p>

Procedure
<ol style="list-style-type: none"><li>1. Have students perform a proper warm up activity. Use the indoor rowers as they are available.</li><li>2. Have a discussion on the importance of proper technique and safety issues.</li><li>3. Separate the students into groups, trying to make the teams as even as possible.</li><li>4. Set the performance monitor for a preset time or distance based on the number of students and the time allotted for the class (setting a preset time might be more efficient here).</li><li>5. Have the student start the race on your command.</li><li>6. Record the score of each team.</li><li>7. If time permits, repeat using a different strategy.</li><li>8. Perform a proper cool down activity.</li></ol>

Assessment Ideas
<ul style="list-style-type: none"><li>• Students count the number of strokes taken per teammate.</li><li>• Students compare their team's score with that of another team of similar age and log the results on the Concept2 online ranking website.</li></ul>

## Rubric #7: Relay Races

Relay	1	2	3	4
<b>Monitor Setup</b>	Unable to set up monitor for a set time or distance	Able to set up monitor for a set time or distance with assistance from teacher	Able to set up monitor for a set time or distance as a team	Able to set up monitor for a set time or distance on own
<b>Technique</b>	Demonstrated poor technique throughout entire relay	Used proper technique 50% of the time	Used proper technique 75% of the time	Used proper technique throughout entire relay
<b>Performance</b>	Participates with little or no intensity	Participates with a moderate level of intensity	Participates with a high level of intensity	Participates with a high level of intensity and encourages teammates to do the same
<b>Teamwork</b>	Demonstrates poor sportsmanship and/or teamwork skills	Shows little tendency toward sportsmanship and/or teamwork skills	Cooperates with teammates and demonstrates good sportsmanship	Organizes teammates toward a positive common goal

## Concept2 Indoor Rowing Lesson Plan #8: 2000 Meter Time Trial

Purpose of the Lesson	Materials Needed
<p>The purpose of this lesson is to measure the level of physical fitness during rowing.</p> <p><b>NASPE Standard 4:</b> Achieves and maintains a health-enhancing level of physical fitness.</p>	<ul style="list-style-type: none"> <li>• Concept2 Indoor Rowers</li> <li>• Pace chart</li> <li>• Computer with internet access</li> </ul>

Expected Outcomes
<p><b>Grades 2-5:</b> Student will view indoor rowing as an international sport and recognize the distance of 2000 meters as the international standard for racing. Use a four minute timed test for meters instead of a 2000 meter preset distance. As students' rowing experience increases, 2000 meters could be attempted. Emphasize the use of proper technique.</p> <p><b>Grades 6-8:</b> Student will view indoor rowing as an international sport and recognize the distance of 2000 meters as the international standard for racing. Student should be able to select a 2000 meter piece from the Workout list of the performance monitor. Student will row at an exertion level that allows completion of 2000 meters, while maintaining proper technique.</p> <p><b>Grades 9-12:</b> Student will view indoor rowing as an international sport and recognize the distance of 2000 meters as the international standard for racing. Student should be able to select a 2000 meter piece from the Workout list of the performance monitor. Emphasis should be placed on using proper rowing technique throughout the 2000 meters. Student will be able to recall the workout data including splits (pace, strokes per minute and time) from the 2000 meter test.</p>

Procedure
<ol style="list-style-type: none"> <li>1. Have a discussion on the sport of indoor rowing and international competition.</li> <li>2. Review pace and intensity.</li> <li>3. Have the students work in pairs and complete the 2000 meters in as little time as they can.</li> <li>4. The student not rowing acts as a coach to the student that is rowing.</li> <li>5. After the time trial is completed the student will recall the information of the 2000 meter piece on the monitor and analyze the data.</li> </ol>

Assessment Ideas
<ul style="list-style-type: none"> <li>• Teacher assesses on proper set-up of the performance monitor for a 2000 meter time trial.</li> <li>• Students offer encouragement to the students performing the rowing piece.</li> <li>• Teacher assesses on efficiency of logging in the result of the time trial on the online ranking.</li> <li>• Student finds a "rower" from another country of similar age and gender from the Concept2 Online Logbook with a similar time for the time trial.</li> </ul>



## Rubric #8: 2000 Meter Time Trial

2000 meter Time Trial	1	2	3	4
<b>Setting Monitor</b>	Unable to set up monitor for 2000 meter piece	Set within 2 to 3 minutes	Set monitor correctly within 2 minutes	Set in less than 2 minutes
<b>Performance</b>	Demonstrated poor technique throughout 2000 meters	Demonstrated proper technique 50% of the time	Demonstrated proper technique for 75% of 2000 meters	Used proper technique throughout entire 2000 meters
<b>Range</b>	Unable to complete 2000 meters	Boys 13-15: >10:00 Boys 16-18: > 9:30  Girls 13-15: > 11:24 Girls 16-18: > 10:00	Boys 13-15:8:24-10:00 Boys 16-18: 7:36-9:30  Girls 13-15: 9:30-11:24 Girls 16-18: 8:30-10:00	Boys13-15: < 8:24 Boys 16-18:< 7:36  Girls 13-15:< 9:30 Girls 16-18:< 8:30
<b>Pace</b>	Inconsistent throughout entire 2000 meters	Consistent through 1000 meters	Consistent through 2000 meters	Consistent through 2000 meters while maintaining a high level of intensity
<b>Recall</b>	Unable to recall feedback from monitor	Able to recall feedback from monitor with assistance	Correctly recalled feedback from monitor	Correctly recalls feedback and split times from monitor

## Rubric #8: Four Minute Assessment

4:00 Assessment	1	2	3	4
<b>Setting Monitor</b>	Could not set monitor for 4:00 with help	Set within 2 minutes with help from teacher	Set monitor correctly within 2 minutes	Set in less than 2 minutes
<b>Technique</b>	Used improper technique throughout 4 minutes	Used proper technique 50% of the time	Used proper technique throughout 4 minutes	Used proper technique through 4 minutes while maintaining high level of intensity
<b>Range</b>	<i>See Row Together Statistical Analysis</i> in the additional resource section. Boys: age 6-9 <539 Boys: age 10-12 <679 Girls: age 6-8 <449 Girls: age 9-10 <559 Girls: age 11-12 <659	<i>See Row Together Statistical Analysis</i> in the additional resource section. Boys: age 6-9 540-679 meters Boys: age 10-12 680-818 meters Girls: age 6-8 450-599 Girls: age 9-10 560-699 Girls: age 11-12 660-759	<i>See Row Together Statistical Analysis</i> in the additional resource section. Boys: age 6-9 680-739 meters Boys: age 10-12 820-899 meters Girls: age 6-8 600-699 meters Girls: age 9-10 700-759 meters Girls: age 11-12 760-836 meters	<i>See Row Together Statistical Analysis</i> in the additional resource section. Boys: age 6-9 > 739 Boys: age 10-12 >899 Girls: age 6-8 > 699 Girls: ages 9-10 >759 Girls: ages 11-12 >836
<b>Pace</b>	Inconsistent throughout four minutes	Consistent through 2 out of 4 minutes	Consistent through 3 out of 4 minutes	Consistent throughout 4 minutes
<b>Recall</b>	Could not recall meters rowed with help	Correctly recall meters rowed with help from teacher	Correctly recalled meters rowed	Correctly recalled meters rowed with splits

## Concept2 Indoor Rowing Lesson Plan #9: Biomechanics of Rowing

Purpose of the Lesson	Materials Needed
<p>The purpose of this lesson is to help the student understand the musculature involved in rowing, the role during the rowing stroke and their effects on performance.</p> <p><b>NASPE Standard 2:</b> Demonstrates understanding of movement concepts, principles, strategies, and tactics as they apply to the learning and performance of physical activities.</p>	<ul style="list-style-type: none"><li>• Concept2 Indoor Rowers</li><li>• Handouts on the Biomechanics of Rowing</li><li>• Muscle group and rowing diagrams</li></ul>

Expected Outcomes
<p><b>Grades 2-5:</b> Emphasis should be placed on knowing which muscle groups play the biggest roles during rowing. Student can identify those muscles on the rowing musculature diagrams.</p> <p><b>Grades 6-8:</b> Emphasis should be placed on knowing which muscle group plays the biggest role during each phase of the rowing stroke (catch, drive, finish, recovery). Student can fill out the rowing musculature chart in small groups.</p> <p><b>Grades 9-12:</b> Emphasis should be placed on knowing which muscle group plays the biggest role during each phase of the rowing stroke (catch, drive, finish, recovery). Student plays Staying Alive game. Student can fill out rowing musculature chart on their own.</p>

Procedure
<ol style="list-style-type: none"><li>1. Have a brief review of the stages of the rowing stroke (catch, drive, finish, recovery).</li><li>2. Review the handout on The Biomechanics of Rowing</li><li>3. Discuss the role of the muscles during each phase of the rowing stroke.</li><li>4. Demonstrate how the muscles coordinate and blend in a smooth manner to create the rowing stroke.</li><li>5. Have students perform rowing technique drills while isolating and identifying with the muscles used during various stages of the stroke.</li><li>6. Students fill out muscle group and rowing diagram.</li></ol>

Assessment Ideas
<ul style="list-style-type: none"><li>• Student fills out the rowing musculature diagrams as homework assignment.</li><li>• Students fill out rowing musculature diagram in small groups.</li></ul>

## Rubric #9: Biomechanics of Rowing

Rowing Biomechanics	1	2	3	4
<b>Identifies Verbally</b>	Cannot Identify which muscle groups play the biggest role during rowing	Identifies which muscle groups play the biggest role during rowing with assistance	Identifies which muscle groups play the biggest role during rowing	Identifies which muscle groups play the biggest role during rowing and the muscles used in each of the 4 phases of the rowing stroke
<b>Demonstrates</b>	Cannot isolate the muscle group used during each of the 4 phases of the rowing stroke with assistance	Can isolate the muscle group used during each of the 4 phases of the rowing stroke with assistance	Can isolate the muscle group used during each of the 4 phases of the rowing stroke	Can isolate the muscle group used during each of the 4 phases of the rowing stroke and can name the muscles used
<b>Identifies Written</b>	Cannot fill out the rowing musculature charts in small groups or with assistance	Can fill out the rowing musculature charts in small groups with assistance	Can fill out the rowing musculature charts in small groups	Can fill out the rowing musculature charts on own

## Concept2 Indoor Rowing Lesson Plan #10: Rowing and Heart Rate

Purpose of the Lesson	Materials Needed
<p>The purpose of this lesson is to understand specificity of training and show the effects of stress during physical activity.</p> <p><b>NASPE Standard 4:</b> Achieves and maintains a health-enhancing level of physical fitness.</p>	<ul style="list-style-type: none"> <li>• Concept2 Indoor Rowers</li> <li>• Heart rate chest belts and pickup cable connections</li> <li>• Heart rate zone worksheets</li> </ul>

### Expected Outcomes

#### Grades 2-5:

Emphasis placed on being able to identify one's heart rate and know the effects rowing can have on heart rate.

#### Grades 6-8:

Student can view heart rate on the performance monitor or a wristwatch receiver with the use of heart rate equipment. Student can manipulate heart rate by changing intensity while rowing and identify the different heart rate zones they are in.

#### Grades 9-12:

Student can view heart rate on the performance monitor or wristwatch receiver with the use of heart rate equipment. Student can fill out the heart rate worksheet. Student can manipulate heart rate by changing intensity while rowing and identify different heart rate zones. Student can track changes in heart rate for a given fixed time or fixed distance workout throughout the school year.

### Procedure

1. Describe the difference between aerobic and anaerobic heart rate zones.
2. Have a brief discussion on the effects of rowing on the cardiovascular system as compared to other activities that are upper or lower body specific.
3. Discuss how increasing the intensity increases the heart rate. Remind students that changing damper setting and stroke rate does not necessarily change the intensity.
4. Demonstrate using the heart rate chest belt and recognizing the heart rate value on the performance monitor.
5. Have the student perform a timed rowing piece using the heart rate function in a target zone of 50%-75% of maximum heart rate.
6. Student makes note of the meters he or she rowed while in the specified target heart rate zone for future reference.

### Assessment Ideas

- Student fills out the heart rate zone worksheet on their own or in small groups.
- Student makes note of the time spent in the correct target heart rate zone and the amount of meters rowed for future reference.
- Student tracks the difference in results through proper or improper training i.e.; more or less meters rowed using the same target heart rate.

## Rubric #10: Rowing and Heart Rate

Rowing and Heart Rate	1	2	3	4
<b>Heart Rate worksheet</b>	Cannot fill out worksheet as a group even with assistance	Fills out worksheet correctly in a group with assistance from teacher	Fills out worksheet correctly in a group	Fills out worksheet correctly on own
<b>Equipment</b>	Cannot put on HR transmitter or view HR on monitor	Can put on a heart rate transmitter and view HR on monitor with some assistance	Can put on a heart rate transmitter and view HR on monitor	Can put on a heart rate transmitter and view HR on monitor and takes care of HR equipment
<b>Manipulates Heart Rate</b>	Unable to manipulate HR by changing intensity	Can raise and lower HR by changing intensity with assistance	Can raise and lower HR by changing intensity	Can raise and lower HR by changing intensity and identify the zone they are in
<b>Sensory</b>	Unable to make relationship between HR on monitor and perceived exertion with assistance	Able to make relationship between HR on monitor and perceived exertion with assistance	Able to view HR on monitor and identify with perceived exertion	Able to view HR on monitor, identify with perceived exertion, and the corresponding zone

## Red Yellow Green

---

### Red Light - Before you get on the indoor rower

- Check that the handle, seat and monorail are clean and free from dirt, sweat and dust.
- Adjust the damper setting to level 3.
- Make sure that the foot strap goes over the crease in you shoes.
- If you have long hair make sure that it is tied back away from your face.
- Make sure that your t-shirt is tucked in.
- Make sure that the monitor is at eye height so that you can see it easily.
- If you are not sure what technique should be used, check with your teacher.

### Yellow Light - While you are rowing

- Sit slightly towards the back of the seat.
- Hold the handle with both hands.
- Do not twist the chain.
- Always keep hold of the handle.
- Make sure that your clothing has not come loose and might get stuck in the monorail.

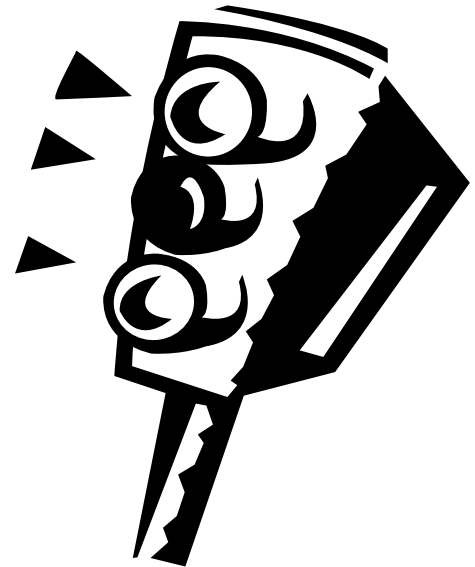

### Green Light - After you have finished

- Replace the handle in the handle hook.
- Wipe down the seat, handle and monorail.

# The Name Game

---

## Resources:

- Indoor rowers.
- Name Game cards.

## Objectives:

- Students become aware of the names of the different parts of the indoor rower.

## Method:

- Students are divided into teams and given the name game cards and some blue tac or clear tape. They are then given 30 seconds to put their cards in the right place on the machines.
- The teacher then assesses how well they have done, telling them how many they have got right and how many wrong. They are then given 30 seconds to change them. Continue this until they have put all of the names in the right place.

## Teaching Points:

- Students learn through a combination of common sense and guided discovery the names of the different parts of the indoor rower.

## Organization:

- Students should start the session away from the indoor rower, which should be separated from each other so that there is plenty of room for the students to move about between the machines while sticking the labels on.

## Assessment:

- Teachers should use this game to assess students knowledge of the names of the different parts of the machine.

**Seat**

**Handle**

**Chain**

**Monitor**

**Fan Cage**

**Flywheel**

**Handle  
Hook**

**Foot Rest**

**Foot Strap**

**Monorail**

**Damper**

**Chain**



# The Weakest Link

---

## Resources:

- Indoor rowers
- The Weakest Link - Student Task Sheet
- Proper Rowing Technique reference sheets for reciprocal teaching
- Technique video
- Pencils

## Objectives:

- Highlight the role of specific body parts used throughout a stroke.
- Encourage technical progression.
- Develop an understanding of basic monitor functions.

## Method:

- As described on the student task sheet.

## Teaching Points:

- Using the information contained under the objectives section above, concentrate efforts on the technical points of the stroke starting with the Catch. Refer to Proper Rowing Technique on page 42.
- Do not bombard rowers with too much technical information. Aim to give student observers a couple of points of good technique to watch out for e.g. on the *arm pull only* phase, tell students to sit tall and imagine that you are balancing a glass of water on the top of your head!

## Organization:

- Rowing machines can be organized in lines and circles etc., but a star shape with all the rowers facing inwards allows the teacher to maintain a good view of all the working machines, as well as those students not actively engaged on the rowing machines.
- Those students not participating on a machine can be given a variety of roles to ensure that they remain on task. These include passive observer, performance judge, reciprocal coach, data recorder or data analyzer.
- Unless you have an experienced rower in your class it is up to the teacher to provide the demonstrations—so make sure to practice first and know what it is about the demonstration that you want to draw the students attention to!

## Assessment:

# The Weakest Link - Student Task Sheet

Your Names \_\_\_\_\_

## Task 1

You are both going to have three turns on the indoor rower. Each time that you get on the machine your teacher will show you how to row. Watch and follow the instructions carefully. On each turn you will pull 15 strokes. Write your first score in box 1, write your second score in box 2 and your third score in box 4.

Name	Arms Only	Arms & Body Swing	Meter Difference	Arms, Body Swing and Legs	Meter Difference
	1	2	3	4	5
	1	2	3	4	5

## Task 2

Now try and work out how many more meters you were able to row using both a body swing and your arms in comparison to using just your arms only. Put your answer in box 3. Can you work out how much further you were able to row when you used your arms, body swing and legs than you did when you just used your arms and a body swing? Write your answer in box 5.

## Task 3

Have another attempt at completing task 1 and use the table below to put your scores into, BUT THIS TIME see if you can beat all of the scores that you got last time!

Remember PRACTICE MAKES PERFECT!

Name	Arms Only	Arms & Body Swing	Meter Difference	Arms, Body Swing and Legs	Meter Difference
	1	2	3	4	5
	1	2	3	4	5

# Staying Alive

---

## Resources:

- Indoor rowers.
- Concept2 Technique Video.
- Proper Rowing Technique sheet.
- Red & White flags/markers.

## Objectives:

- Encourage good technique.
- Encourage lower stroke rates.
- Understand the meaning of SPM or 'strokes per min' on the monitor display.

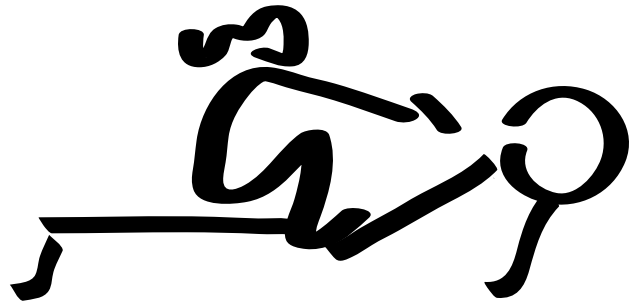

## Method:

1. Set the monitor to a pre-specified time or distance ie. 2 mins. or 500m.
2. Give each rower a number of 'lives' ie. 5.
3. Tell all rowers that they must try to complete their row and at the same time maintain a constant stroke rate trying to keep within the 'zone.' This zone, for example, could be between 25 - 30 strokes per minute.
4. Each rower should be watched by a partner. Each time that they fall out of the zone they lose one of their lives. This continues until either they lose all of their lives, or they complete their time/distance. **Note:** Allow approximately ten strokes before they begin to lose lives as inexperienced rowers will need this time to find and settle into the zone.
5. Points can be awarded to teams/individuals as the teacher sees fit.
6. The white flag can be held up until a rower loses all his/her lives and then a red flag is displayed. This visual aid helps the rowers to gauge their performance against the other rowers, this often encourages them to try harder next time.

## Teaching Points:

- This challenge should only be attempted once rowers have been introduced to the SPM feature on the monitor display and have had a chance to find out what their average SPM is, having completed a timed row.
- Many students new to indoor rowing seem to think that they are only working hard if they pull lots of short strokes as quickly as they can. The problems with this are twofold. First, short strokes are a very inefficient way of covering distance, and so complete strokes should be encouraged from the start. Second, moving up and down the monorail at speed can only be maintained for a very short time. Students must be encouraged to understand the need to pace themselves in just the same way as they would in a running race.
- Students need to recognize that power can be achieved in each and every stroke provided that each stroke is completed in a controlled, technically correct manner and at a pace they can maintain for the duration of the row.
- It is useful to get the students to listen to the difference in sound that the flywheel makes when short, rapid strokes are made, and compare that to the sound that it makes when

## Staying Alive

---

longer, more powerful strokes are taken. Students can even be asked to close their eyes and listen. They can then try to guess which style of stroke has achieved the furthest distance on the monitor in a given number of strokes i.e. 10.

- As students become more efficient technically, they will find it easier to work within given zones. To begin, aim to bring the SPM below 30, so a zone of 25 - 30 could be used. As they improve gradually bring this down to 22 - 24 SPM. Widening the zone will make the challenge easier, narrowing it will make it harder!
- This challenge can be extended further as students really begin to improve. Set a low, narrow SPM and a timed challenge e.g. 3 mins. They must try to stay within the zone for that row, but the challenge is also to see who can row the furthest. Now they are having to focus not only on stroke rate, but also on the power of each stroke.

### Organization:

- This challenge can be completed as individuals, working in pairs, or as a team competition. However, it is best to let individuals try first so that they can make their initial attempts without the pressure of being part of a team.
- Lots of different points systems can be devised by the teacher and the students themselves. Distances can be tallied up as each team member makes their attempt at the challenge. If they lose all their lives before completing the challenge the distance achieved is recorded. A 50m additional reward can be given to rowers who complete the challenge without losing all their lives.
- This challenge is best suited to a star shaped arrangement of machines as all rowers are able to see each other.
- When doing a team competition try to ensure that each team judges another.
- Those students not participating on a machine can be given a variety of roles to ensure that they remain on task. These include passive observer, performance judge, coach, data recorder or data analysis.

### Progression:

- Staying Alive can also be used with students targeting a range of watts, pace/500m time or calories to draw student's attention to the different capabilities of the monitor.

# Frantic Relay

---

## Resources:

- Indoor rowers

## Objectives:

- Finish a technical session.
- Develop teamwork.



## Method:

- In teams, students row a specific length of time, i.e. 30 seconds, then swap over, until all students have tried the indoor rower. If there are uneven numbers then one member of the smallest teams must row twice.
- A variation on this is the team race over a specific distance with team members rowing different distances depending on their strengths. This helps to give students an awareness of their strengths and weaknesses.
- Students not rowing should be holding the rowers feet and making sure that the rowing machine does not move, this will help improve the score achieved.

## Organization:

- Students should work on the machine that they have used throughout the lesson to prevent wasted time reselecting teams. If one team is obviously stronger than the rest of the teams then a handicapping system should be used.



# Indoor Rower Pace Chart

Use this chart to predict your final time or distance for the workouts shown.

Average pace per	Your time will be:					Your distance will be:	
	500m	1000m	2000m	5000m	6000m	10,000m	30 min.
1:40	3:20	<b>6:40</b>	16:40	20:00	33:20	9000	18,000
1:42	3:24	<b>6:48</b>	17:00	20:24	34:00	8824	17,647
1:44	3:28	<b>6:56</b>	17:20	20:48	34:40	8654	17,308
1:46	3:32	<b>7:04</b>	17:40	21:12	35:20	8491	16,981
1:48	3:36	<b>7:12</b>	18:00	21:36	36:00	8333	16,667
1:50	3:40	<b>7:20</b>	18:20	22:00	36:40	8182	16,364
1:52	3:44	<b>7:28</b>	18:40	22:24	37:20	8036	16,071
1:54	3:48	<b>7:36</b>	19:00	22:48	38:00	7895	15,789
1:56	3:52	<b>7:44</b>	19:20	23:12	38:40	7759	15,517
1:58	3:56	<b>7:52</b>	19:40	23:36	39:20	7627	15,254
2:00	4:00	<b>8:00</b>	20:00	24:00	40:00	7500	15,000
2:02	4:04	<b>8:08</b>	20:20	24:24	40:40	7377	14,754
2:04	4:08	<b>8:16</b>	20:40	24:48	41:20	7258	14,516
2:06	4:12	<b>8:24</b>	21:00	25:12	42:00	7143	14,286
2:08	4:16	<b>8:32</b>	21:20	25:36	42:40	7031	14,063
2:10	4:20	<b>8:40</b>	21:40	26:00	43:20	6923	13,846
2:12	4:24	<b>8:48</b>	22:00	26:24	44:00	6818	13,636
2:14	4:28	<b>8:56</b>	22:20	26:48	44:40	6716	13,433
2:16	4:32	<b>9:04</b>	22:40	27:12	45:20	6618	13,235
2:18	4:36	<b>9:12</b>	23:00	27:36	46:00	6522	13,043
2:20	4:40	<b>9:20</b>	23:20	28:00	46:40	6429	12,857
2:22	4:44	<b>9:28</b>	23:40	28:24	47:20	6338	12,676
2:24	4:48	<b>9:36</b>	24:00	28:48	48:00	6250	12,500
2:26	4:52	<b>9:44</b>	24:20	29:12	48:40	6164	12,329
2:28	4:56	<b>9:52</b>	24:40	29:36	49:20	6081	12,162
2:30	5:00	<b>10:00</b>	25:00	30:00	50:00	6000	12,000
2:32	5:04	<b>10:08</b>	25:20	30:24	50:40	5921	11,842
2:34	5:08	<b>10:16</b>	25:40	30:48	51:20	5844	11,688
2:36	5:12	<b>10:24</b>	26:00	31:12	52:00	5769	11,538
2:38	5:16	<b>10:32</b>	26:20	31:36	52:40	5696	11,392
2:40	5:20	<b>10:40</b>	26:40	32:00	53:20	5625	11,250
2:42	5:24	<b>10:48</b>	27:00	32:24	54:00	5556	11,111
2:44	5:28	<b>10:56</b>	27:20	32:48	54:40	5488	10,976
2:46	5:32	<b>11:04</b>	27:40	33:12	55:20	5422	10,843
2:48	5:36	<b>11:12</b>	28:00	33:36	56:00	5357	10,714
2:50	5:40	<b>11:20</b>	28:20	34:00	56:40	5294	10,588
2:52	5:44	<b>11:28</b>	28:40	34:24	57:20	5233	10,465
2:54	5:48	<b>11:36</b>	29:00	34:48	58:00	5172	10,345
2:56	5:52	<b>11:44</b>	29:20	35:12	58:40	5114	10,227
2:58	5:56	<b>11:52</b>	29:40	35:36	59:20	5056	10,112
3:00	6:00	<b>12:00</b>	30:00	36:00	60:00	5000	10,000

# Proper Rowing Technique

- Request a copy of our free Technique DVD if you don't already have one. Then visit [concept2.com](http://concept2.com) to view a video clip of rowing.
- Have someone watch you to help you match your body positions to those shown below.
- These positions should be blended together to make a smooth and continuous stroke with no stopping at any point in the stroke.
- Aim for a stroke rate of between 24 and 30 strokes per minute as displayed on the Performance Monitor.
- Grip should be loose and comfortable; wrists should be level.

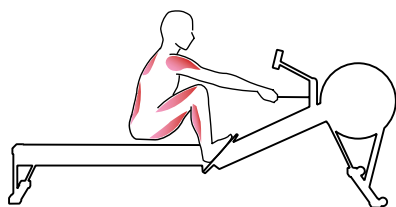

## the catch

- Extend your arms straight toward the flywheel.
- Keep wrists flat, shoulders low and relaxed.
- Lean your upper body slightly forward with back straight but not stiff.
- Slide forward on the seat until your shins are vertical (or as close to this as your flexibility will allow).

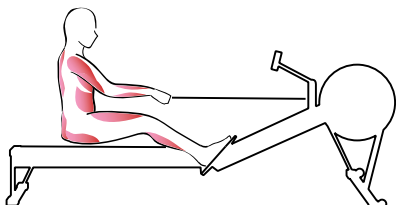

## the drive

- Begin the drive by pressing down your legs.
- Keep your arms straight at first and hold your back firm to transfer your leg power up to the handle.
- Gradually swing back with your upper body, bending your arms and prying against the legs until you reach a slight backward lean at the finish.

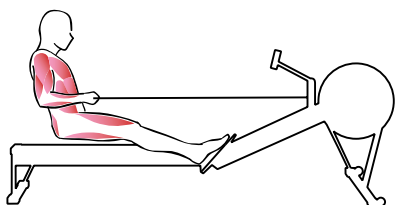

## the finish

- Pull handle all the way into your abdomen.
- Straighten your legs.
- Lean your upper body back slightly.
- Keep shoulders low and relaxed.

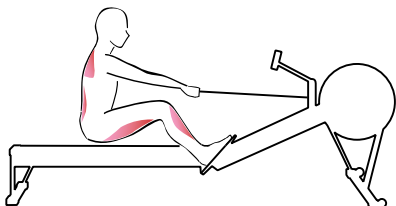

## the recovery

- Extend your arms toward the flywheel.
- Lean your upper body forward at the hips to follow the arms.
- Gradually bend legs to slide forward on the seat.
- Be sure your arms are extended before you bend your knees.

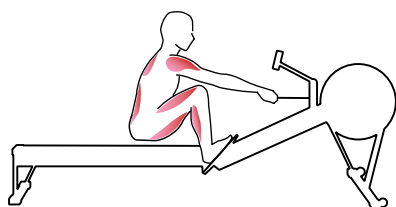

## the catch

- Draw your body forward until the shins are vertical.
- Upper body should be leaning forward at the hips.
- Arms should be fully extended.
- You are ready to take the next stroke.



## Technique Review

### Common Problems to Avoid:

Note that the shadowed figure is in the incorrect position.

#### Common Problem 1: Too Much Forward Reach



**WRONG:** The seat nearly hits the heels, the shins are past the vertical, the body leans too far forward, and the head and shoulders drop toward the toes. This puts the body in a weak position for the start of the next stroke.

**RIGHT:** The seat remains at least 7-10 inches from the heels, the shins are nearly vertical, the body leans comfortably forward, and do not drop the head and shoulders.

#### Common Problem 2: Rocking On (Opening Back too Early)



**WRONG:** The rower pulls the handle by leaning back rather than by pressing the legs. This wastes the power of the legs and may strain the back.

**RIGHT:** The legs should start the drive with the body still leaning forward. The back then gradually opens, prying against the extended legs.

#### Common Problem 3: Shooting the Tail (Opening Back Too Late)



**WRONG:** The rower starts the drive by extending the legs without moving the handle. The power of the legs is wasted.

**RIGHT:** The body needs to come along with the legs, thereby transferring the legs' power into the handle. The back then gradually opens, prying against the extended legs. Hips and handle move together.

#### Common Problem 4: Early Knee Bend on the Recovery



**WRONG:** On the recovery, the rower lets the knees come up before the arms are fully extended. As a result, either the knees and hands collide (thud!) or the hands are forced to travel upward in a big arc to avoid the knees (unnecessary work for arms!).

**RIGHT:** The rower should extend the arms completely and lean the upper body forward from the hips BEFORE bending the knees to slide forward. This gets the hands out nicely ahead of the knees.

#### Common Problem 5: Excessive Layback & Pulling Up to Chin

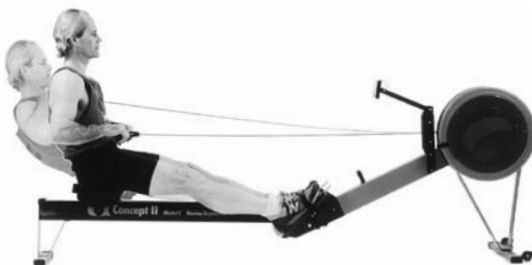

**WRONG:** The rower leans back too far at the finish and/or pulls the handle all the way up to the chin. This is an inefficient use of the arms and exposes the back to potential strain.

**RIGHT:** The handle should be pulled to within one inch of the abdomen, halfway between the lap and the chest. The upper body should have a 5-10 degree backward lean.



# Heart Rate Monitoring

---

## Plotting Performance – Beat By Beat

Monitoring heart rate allows you to maximize the effectiveness of your training time. It helps you to adjust your effort so that you can achieve the goals of each workout.

The first step is to determine your **Maximum Heart Rate (MHR)** and **Resting Heart Rate (RHR)** so that you can use them to establish your **Training Heart Rate Range (THRR)**. One way to do this is to have a stress test done. Your physician can then tell you what your maximum and resting heart rates are and what training range would be best for you. The other way is to use the mathematical formulas explained below, which will give you a pretty good approximation.

To estimate your maximum heart rate, you can use the rule of thumb that your maximum heart rate (MHR) is 220 minus your age. You can find your resting heart rate (RHR) by lying down or sitting still for a while and then taking your pulse (do this several times and take the average for greater accuracy). By subtracting RHR from MHR, you will determine your heart rate reserve (HRR). You can then calculate your training heart rate range by taking prescribed percentages of this HRR and adding them back to your RHR. Specifically, for aerobic training you will take 50-75% of your HRR and add it to your RHR to get your training heart rate range. For anaerobic threshold training you will take 80-85% of the HRR and add it back to your RHR to get your training range. The following examples will show you how to do this. Then you can use the worksheet provided to calculate your own values.

### Aerobic Training Heart Rate Range

Let's say you are 15 years old, with a resting heart rate of 50. Using 220 minus your age,  $220 - 15$ , you calculate a MHR of 205. Subtracting RHR from MHR, you get  $205 - 50 = 155$  for your HRR. Your aerobic training heart rate range will lie between 50% and 75% of your HRR: 50% of 155 = 77; 75% of 155 = 116. Adding these figures back on to your resting heart rate gives:  $50 + 77 = 127$  and  $116 + 50 = 166$ . Thus your aerobic THRR is 127 to 166 beats per minute. If you exercise below 127, you will decrease the efficiency of your workout. If you exercise above 166 for any length of time, you will feel some stress.

### Anaerobic Threshold Heart Rate Range

The anaerobic threshold is the zone in between aerobic and anaerobic training. On a strong 5000 meter piece, or a best effort for 30 minutes, you are probably working at your anaerobic threshold. To calculate this range, take 80 to 85% of your HRR. Using the HRR of the first example we get: 80% of 155 = 124 and 85% of 155 = 132. Adding these figures back on to your RHR gives:  $124 + 50 = 174$  and  $132 + 50 = 182$ . Thus your anaerobic threshold THRR is 174 to 182 beats per minute.

# Heart Rate Monitoring

## Beyond Anaerobic Threshold

Going beyond your anaerobic threshold range is asking your body to work purely anaerobically. Anaerobic workouts are usually interval workouts, simply because your body can't work anaerobically for very long at a time without rest. You may do all-out intervals ("putting the pedal to the metal") or repeated intervals. All-out intervals, where you may reach your MHR, call for a longer rest interval to reach a lower heart rate before the next interval. Repeats, where your heart rate should be just under MHR, call for a higher heart rate at restart.

## For Best Results

For best results on the indoor rower, we recommend using all three types of workouts. The variety will provide your body with a range of productive stresses, while avoiding boredom and the overuse of any one system. Your largest serving of the three should be of aerobic work, where duration takes priority over high intensity.

## Monitor Your Progress

Monitoring your training heart rate and your indoor rower scores enables you to track your fitness progress. In addition, periodic test pieces will be very informative to you. As your fitness improves, you will find that you can achieve more meters, watts or calories for a given heart rate. Or, at the same pace, your heart rate will be lower. You may also find a reduction in your resting heart rate.

On the other hand, if you find increases in your heart rate for a given work level, or increases in your resting heart rate, it may mean that you need some time off. You may be overly fatigued or showing the beginnings of an illness.

Knowing how your cardiovascular system is responding to training will enhance your interest in your health and well-being. Monitoring your heart rate is a good start.

### Use This Worksheet to Calculate Your Own Aerobic & Anaerobic Training Ranges

Estimated Maximum Heart Rate (MHR):

$$220 - \boxed{\text{your age}} = \boxed{\text{MHR}}$$

Estimated Resting Heart Rate (RHR):

$$\boxed{\text{RHR}}$$

Estimated Heart Rate Reserve (HRR):

$$\boxed{\text{MHR}} - \boxed{\text{RHR}} = \boxed{\text{HRR}}$$

Aerobic Range:

$$\boxed{\text{HRR (from above)}} \times .50 = \boxed{\text{X1}} \quad \text{---} \rightarrow \quad \boxed{\text{X1}} + \boxed{\text{RHR (from above)}} = \boxed{\text{low end Aerobic THRR}}$$

$$\boxed{\text{HRR (from above)}} \times .75 = \boxed{\text{X2}} \quad \text{---} \rightarrow \quad \boxed{\text{X2}} + \boxed{\text{RHR (from above)}} = \boxed{\text{high end Aerobic THRR}}$$

For aerobic work, work between these two HR ↑

Anaerobic Range:

$$\boxed{\text{HRR (from above)}} \times .8 = \boxed{\text{X1}} \quad \text{---} \rightarrow \quad \boxed{\text{X1}} + \boxed{\text{RHR (from above)}} = \boxed{\text{low end Anaerobic THRR}}$$

$$\boxed{\text{HRR (from above)}} \times .85 = \boxed{\text{X2}} \quad \text{---} \rightarrow \quad \boxed{\text{X2}} + \boxed{\text{RHR (from above)}} = \boxed{\text{high end Anaerobic THRR}}$$

For anaerobic work, work between these two HRs

## Row Together Program Statistical Analysis for 1997-2004

The data below was collected from students at the elementary, middle, and high school level from 1997 to 2004 as part of the Concept2's Row Together program. Each student provided their age, sex, height and weight, and performed a 4-minute row using the Concept2 Indoor Rower. Their total meters rowed and watts generated were recorded.

The students' resulting data was analyzed by Exercise Physiologist Dr. Fritz Hagerman at Ohio State University and put into the statistical format below. The students are grouped by sex and age. The terms 'fair,' 'average,' 'good,' and 'excellent' are generic terms. You can use the data to provide a benchmark for students when performing the 4-minute timed assessment on the indoor rower.

Meter-Watts/4 min		#	Fair	Avg.	Good	Excellent	Mean
Boys 6-9	meters	1283	~ 539	540 ~ 679	680 ~ 739	740 ~	600.8
	watts	1283	~ 29.9	30 ~ 59.9	60 ~ 79.9	80 ~	46.9
Boys 10-12	meters	4096	~ 679	680 ~ 818	820 ~ 899	900 ~	745.5
	watts	3807	~ 59.9	60 ~ 109.9	110 ~ 139.9	140 ~	85.6
Boys 13-15	meters	4253	~ 799	800 ~ 949	950 ~ 1049	1050 ~	867.8
	watts	4184	~ 99.9	100 ~ 169.9	170 ~ 219.9	220 ~	136.6
Boys 16-18	meters	1231	~ 849	850 ~ 1049	1050 ~ 1149	1150 ~	943.7
	watts	1231	~ 139.9	140 ~ 219.9	220 ~ 279.9	280 ~	176.7
<b>Total Boys</b>	<b>meters</b>	<b>10863</b>					
	<b>watts</b>	<b>10505</b>					
Girls 6-8	meters	666	~ 449	450 ~ 599	600 ~ 699	700 ~	539.1
	watts	666	~ 19.9	20 ~ 39.9	40 ~ 59.9	60 ~	33.6
Girls 9-10	meters	1282	~ 559	560 ~ 699	700 ~ 759	760 ~	629.4
	watts	1282	~ 34.9	35 ~ 64.9	65 ~ 89.9	90 ~	52.9
Girls 11-12	meters	3268	~ 659	660 ~ 759	760 ~ 839	840 ~	715.4
	watts	2965	~ 59.9	60 ~ 94.9	95 ~ 119.9	120 ~	76.1
Girls 13-14	meters	3099	~ 679	680 ~ 819	820 ~ 899	890 ~	745.6
	watts	2998	~ 59.9	60 ~ 109.9	110 ~ 139.9	140 ~	87.2
Girls 15-17	meters	1835	~ 699	700 ~ 839	840 ~ 939	940 ~	763.3
	watts	1835	~ 69.9	70 ~ 119.9	120 ~ 149.9	150 ~	95.0
Girls 18-19	meters	124	~ 649	650 ~ 799	800 ~ 944	950 ~	742.8
	watts	124	~ 59.9	60 ~ 109.9	110 ~ 159.9	160 ~	88.6
<b>Total Girls</b>	<b>meters</b>	<b>10274</b>					
	<b>watts</b>	<b>9870</b>					
<b>Total Students</b>	<b>meters</b>	<b>21137</b>					
	<b>watts</b>	<b>20375</b>					

# Indoor Rower Layout

## Where to Position Yourself

Instructing group rowing workouts is an exciting opportunity to empower each rower to model perfect rowing techniques within their own comfort zones. Rowing instructors act as coaches and facilitators as opposed to all-star leaders. This unique responsibility requires the instructor to position himself/herself appropriately when facilitating the workout. The following items should be considered when deciding where to place yourself among your rowing crew:

- Shape of the room
- Number of rowing rows
- Location of mirrors: 1–5 feet above the floor (height from the floor, 0–12 inches; maximum height for mirror top, 5 feet)
- Experience level of participants
- Arrangement of rowers (see below)

No matter where you choose to position yourself, you should always maintain eye contact with your rowers in addition to allowing 3.6 feet between parallel indoor rowers.

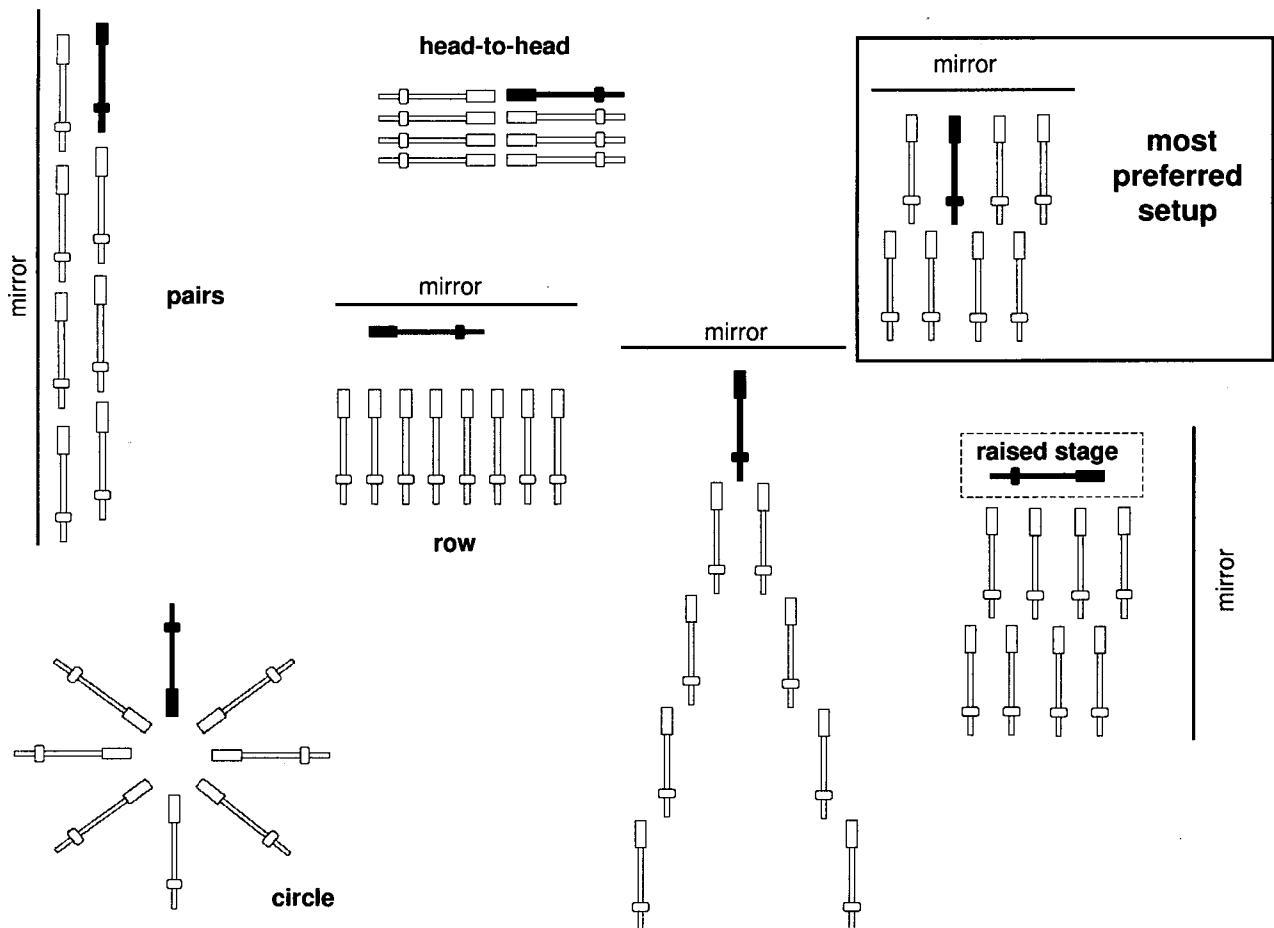

# QUICK FACTS

---

- Rowers are probably the world's best athletes. Rowing looks graceful, elegant and sometimes effortless when it is done well. Don't be fooled. Rowers haven't been called the world's most physically fit athletes for nothing. The sport demands endurance, strength, balance, mental discipline, and an ability to continue on when your body is demanding that you stop.
- Rowing is one of the original sports in the modern Olympic Games.
- Rowing was the first intercollegiate sport contested in the United States. The first rowing race was between Harvard and Yale in 1852.
- Boats such as single rowing sculls may be as narrow as 10 inches across, weigh only 23 pounds, and stretch nearly 27-feet long.
- The Concept2 Model A ergometer was introduced in 1981 by the Dreissigacker brothers.
- Indoor rowing works more muscle groups and joints than any other exercise.
- Indoor rowing is a great aerobic workout that exercises the whole body: legs, arms, back, abdomen, and buttocks. Trade in your weights and running route – rowing is cardio and strength training all in one!
- Indoor rowing is a great calorie burner. Research shows that rowing burns calories faster than working out on a treadmill, exercise bike or stairclimber at the same intensity and duration. In fact, during a 20-minute rowing workout, the average person will burn 200 to 300 calories—roughly 40 to 100 more calories than he/she would burn on the other fitness machines mentioned.
- Today, the C.R.A.S.H.-B. World Indoor Rowing Championships is the world's premier indoor rowing race. Held in Boston, the event draws thousands of competitors and spectators from around the world, all of whom compete exclusively on Concept2 Indoor Rowers.
- Indoor rowing is a lifelong sport.  
A simple, easy-to-learn exercise, indoor rowing is a terrific sport for all ages. Ernestine Bayer, known as the mother of American women's rowing, competed in the C.R.A.S.H.-B. Sprints at age 93, rowing 2000 meters in 12 minutes!
- Indoor rowing is ideal cross-training exercise for a variety of sports from skiing to golf.

# The Biomechanics of Rowing

## Key Components

There are four key components to the basic rowing stroke: the catch, the drive, the finish, and the recovery. The catch begins by grasping the handle evenly with both hands, with the seat slid forward so the knees are tucked into the chest and directly in line with the heel region of the foot. The arms are stretched out in front and the body is leaning slightly forward from the hips. To begin the drive, press firmly against the foot stretchers until the legs are almost fully extended, but not locked. Let the arms “go for the ride” as you slowly pull them toward the abdomen with the torso at a 90 degree angle with the monorail. In the finish, the arms are pulled all the way into the abdomen with the legs fully extended and your torso leaning back slightly beyond 90 degrees. For the recovery, extend the arms, bend your legs, and lean forward from the hips. As you do this, slide forward to start the next catch. The arms must pass over the knees before the knees bend. All four phases should be executed in a smooth, continuous, and fluid manner.

## Biomechanics

The basic rowing action is a coordinated muscle action that requires application of force in a repetitive, maximal, and smooth manner. Every large muscle group will contribute to this action. The muscle requirements have been analyzed by Dr. Thomas Mazzone.<sup>1</sup> The rowing action has been divided into the following sequence:

- 1) the catch
- 2) the drive - leg emphasis
  - body swing emphasis
  - arm pull through emphasis
- 3) the finish
- 4) the recovery

## The Catch

The erector spinae muscles of the back are relaxed to allow for trunk flexion, which is provided by the abdominals. The psoas major and minor and the iliacus flex the pelvis and hips. The sartorius muscle rotates the thighs which allows the body to flex between the thighs to obtain maximum reach. The hamstrings and gastrocnemius are contracting while the knees are in flexion. The quadriceps are elongated and stretched, yet the rectus femoris is contributing to hip flexion. The ankles are dorsiflexed by the tibialis anterior.

The elbows are extended by the triceps brachii. The grip on the handle is accomplished by the flexor muscles of the fingers and thumb.

## The Catch

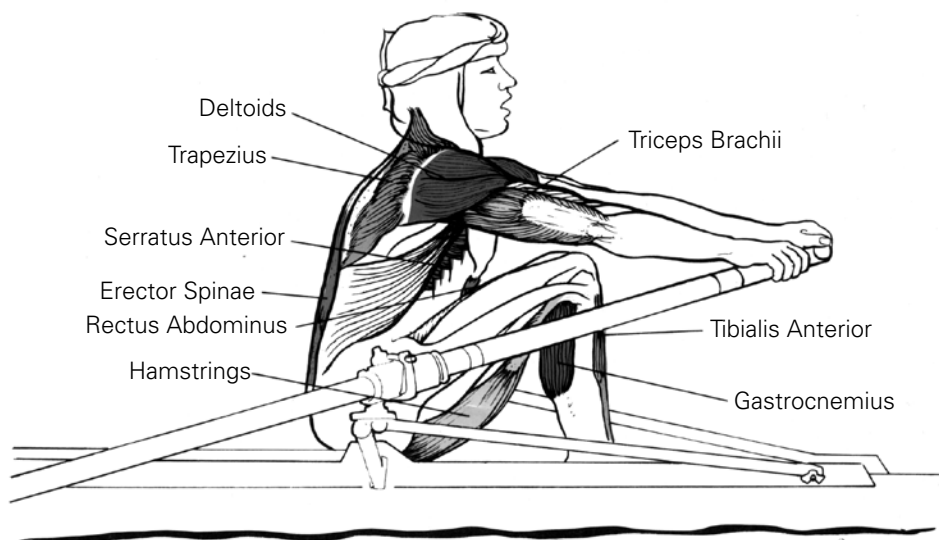

1. Kinesiology of the rowing stroke, NSCA Journal, Volume 10, Number 2, 1988, Thomas Mazzone, M.D. Wyoming County Community Hospital, Warsaw, New York

# The Biomechanics of Rowing - continued

## The Drive

### Legs Emphasis

The initial portion of the drive demands maximal power from the legs. The quadriceps extend the knee, and the feet are plantar flexed by the soleus and gastrocnemius muscles. A number of stabilizing muscles aid in supporting the lower back.

All the muscles of the shoulder are contracting. These include the supra and infraspinatus, subscapularis, teres major and minor, and the biceps brachii. The scapula is stabilized by the serratus anterior and trapezius muscles.

### The Drive - Legs Emphasis

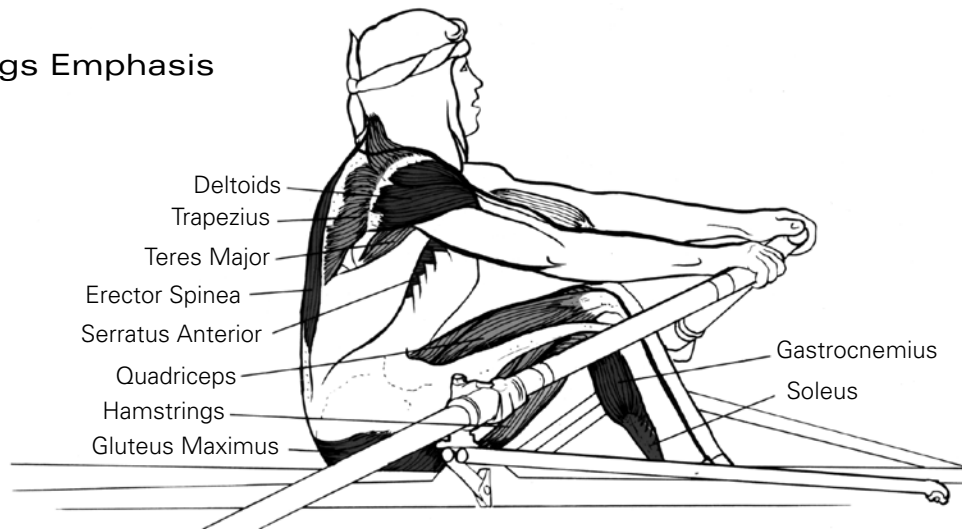

### Body Swing Emphasis

As the knees are finishing their extension, the hip is also extending by the contraction of the gluteus and hamstring muscles. Back extension is occurring by contraction of the erector spinae.

In the upper body, elbow flexion is occurring via the biceps, brachialis, and the brachioradialis muscles.

### The Drive - Body Swing

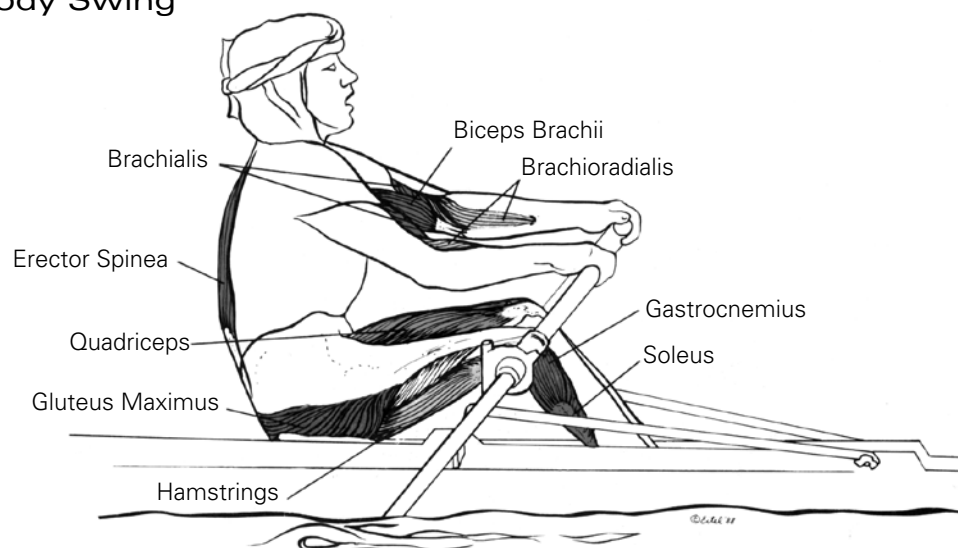



# The Biomechanics of Rowing - continued

## The Drive

### Arm Pull Through

The knees are maximally extended, and the ankles are plantar flexed. In addition, hip and back extension are being completed. The upper body musculature is contracting with high force to finish the drive. The elbow flexors are dominant. The flexor and extensor carpi ulnaris muscles of the forearm contract to stabilize and adduct the wrist. The shoulder is extended and adducted. The upper arm is internally rotated by the latissimus dorsi and pectoralis major. The teres minor, posterior deltoid, and long head of the biceps are acting on the shoulder joint. The scapula is rotated downward by the pectoralis minor and then drawn backward by the trapezius and rhomboid muscles.

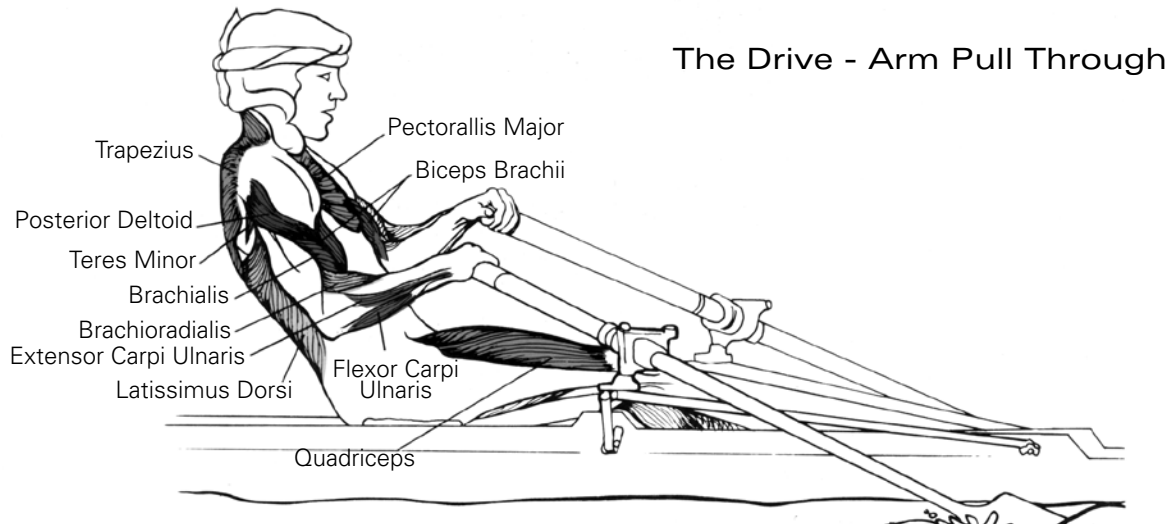

## The Finish

The knees and ankles remain constant as the hips complete a full extension. The back extensors are continually contracting, and the upper arms are internally rotated by the contracting latissimus dorsi. The triceps are extending the elbows slightly.

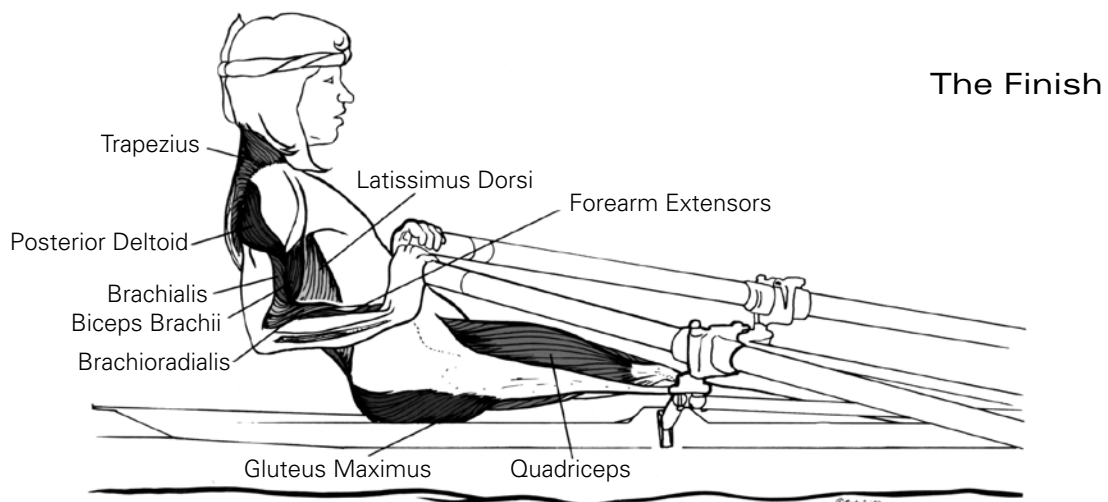



## The Biomechanics of Rowing - continued

---

### *The Recovery*

The arms are pushed forward and away from the body by the triceps until the elbows reach full extension. The anterior deltoids contract along with the coracobrachialis and biceps, and the upper arms raise slightly as they pass over the extended knees. The abdominals flex the torso, and once the hands have cleared the extended knees, the slide begins its forward motion through ankle dorsiflexion and hip and knee flexion.

### The Recovery

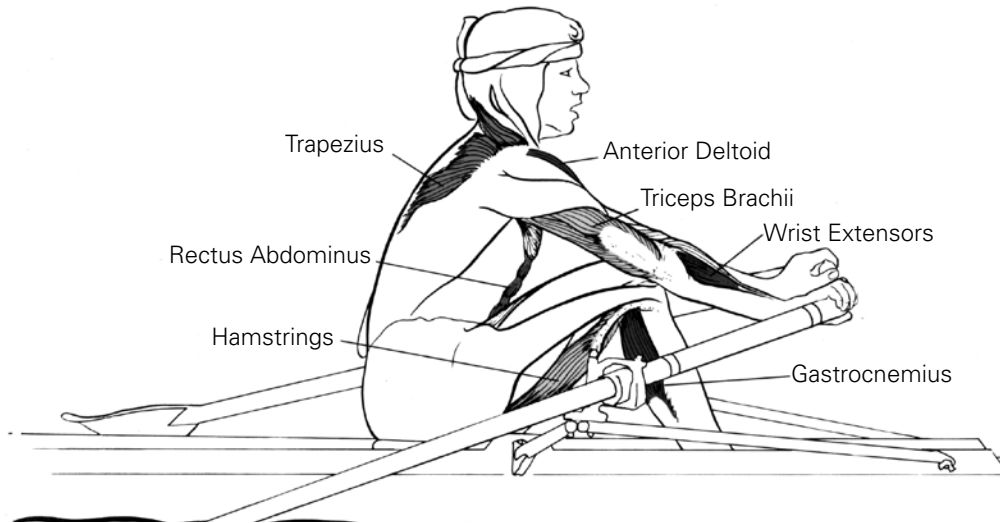

# Muscle Groups 1 - Catch

---

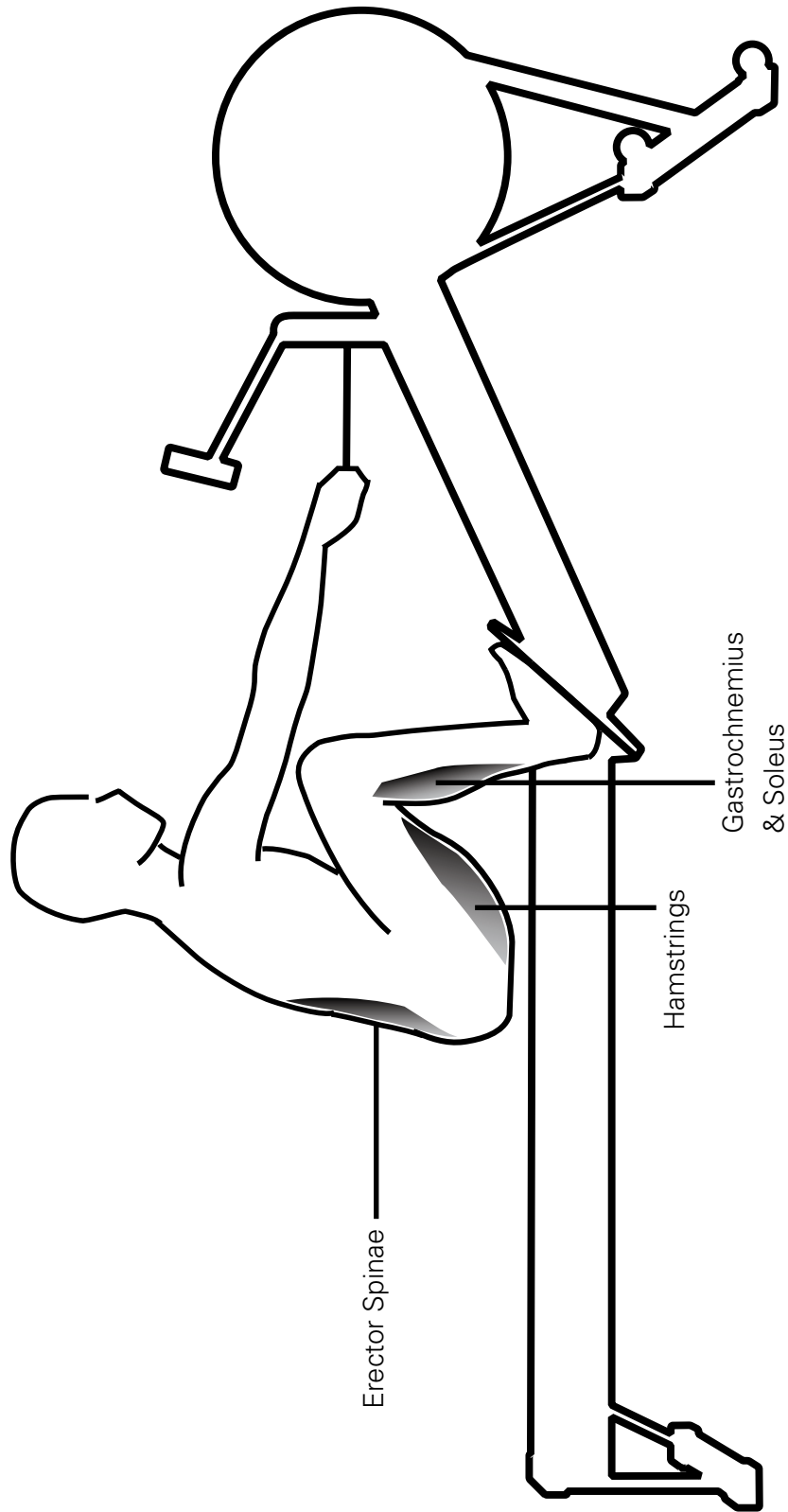

# Muscle Groups 1 - Catch

---

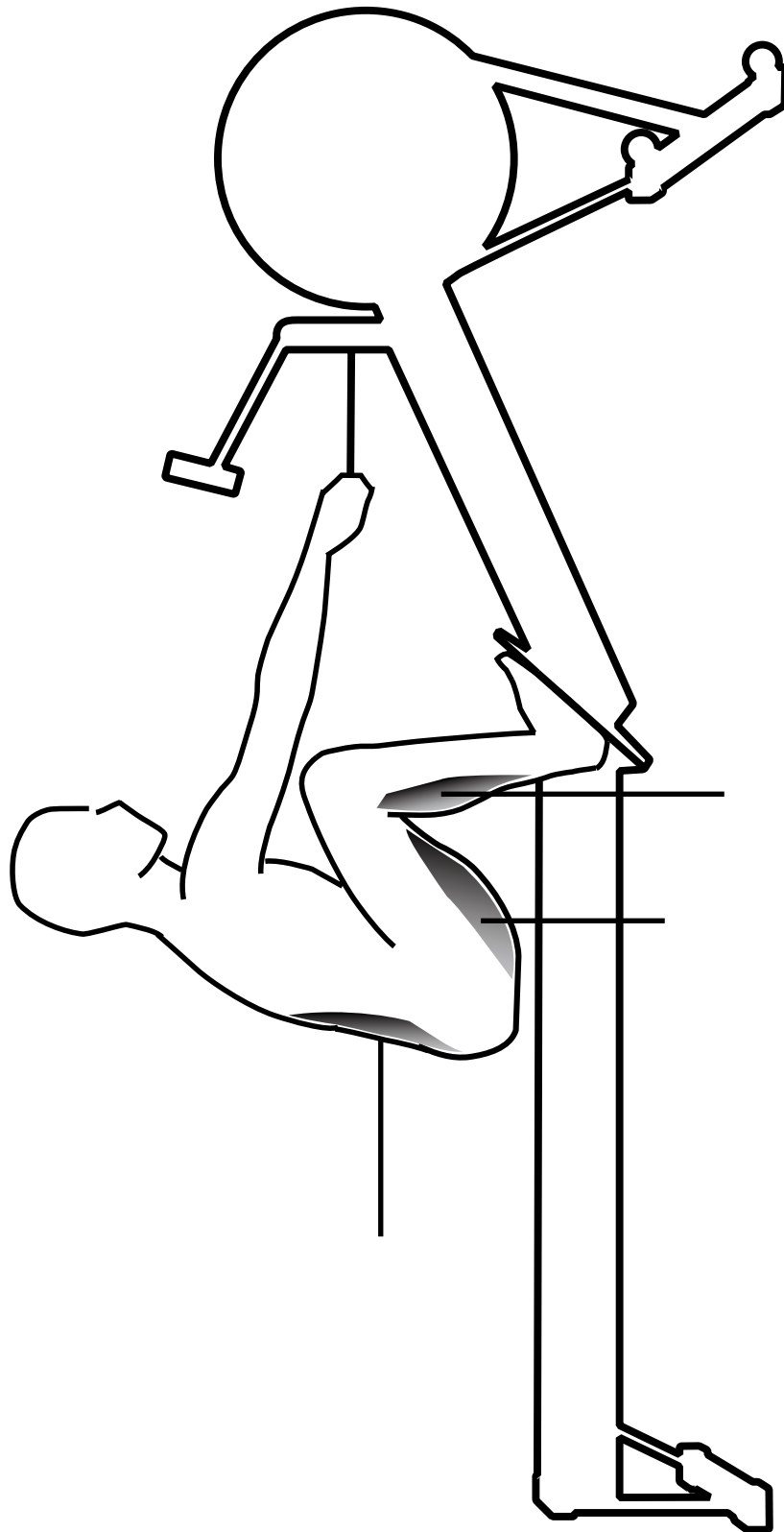

# Muscle Groups 2 - Drive

---

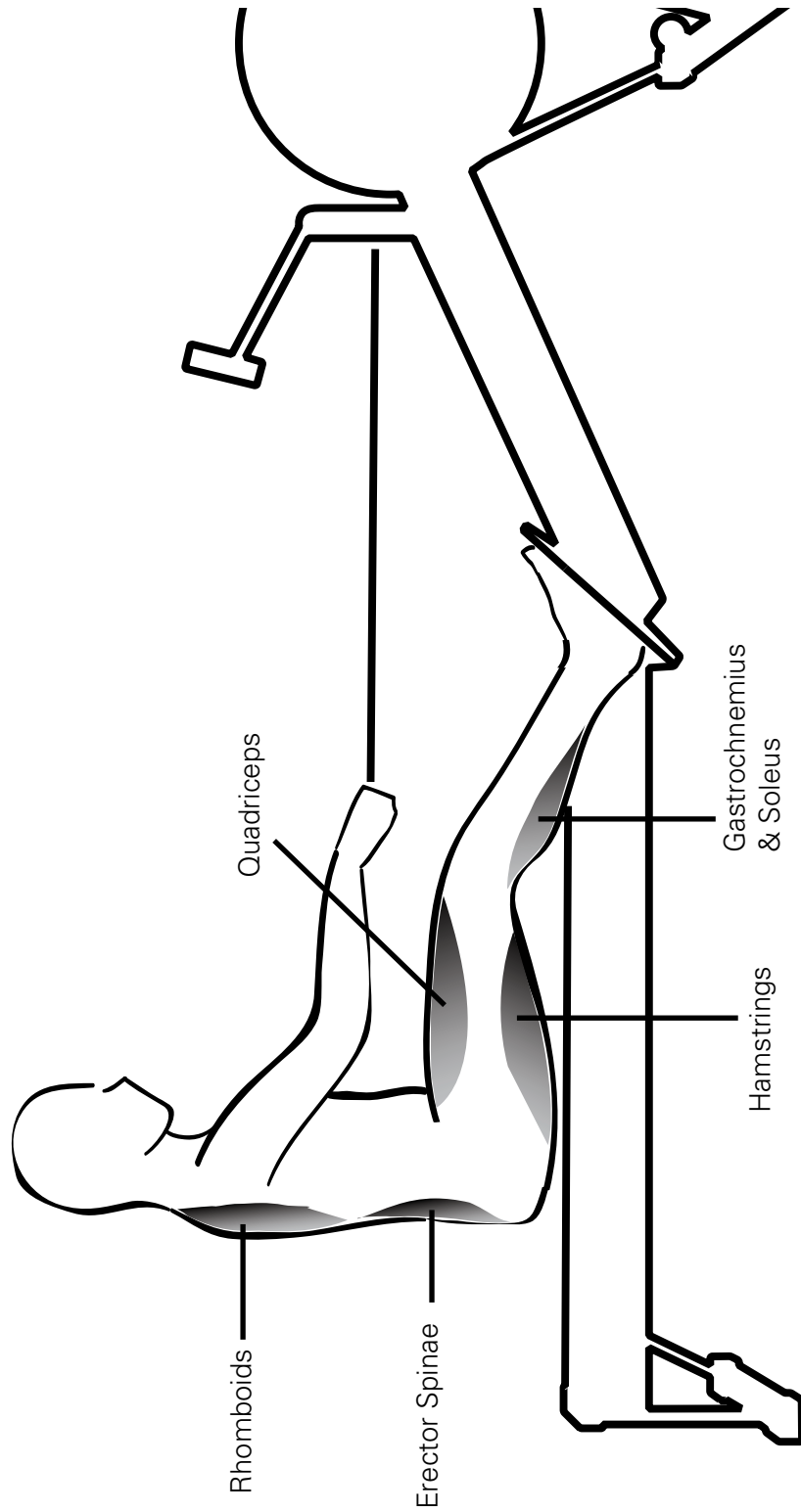

# Muscle Groups 2 - Drive

---

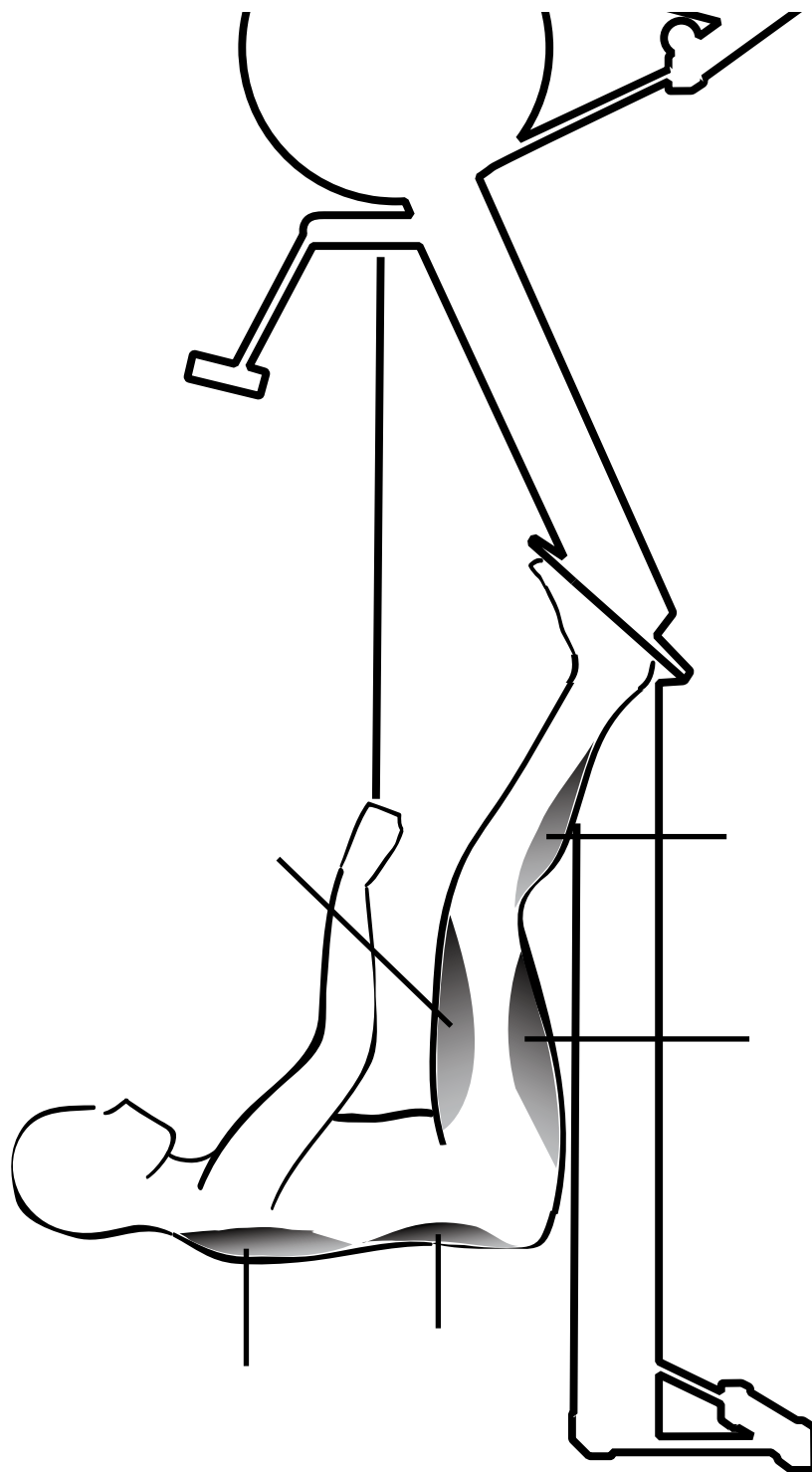

# Muscle Groups 3 - Finish

---

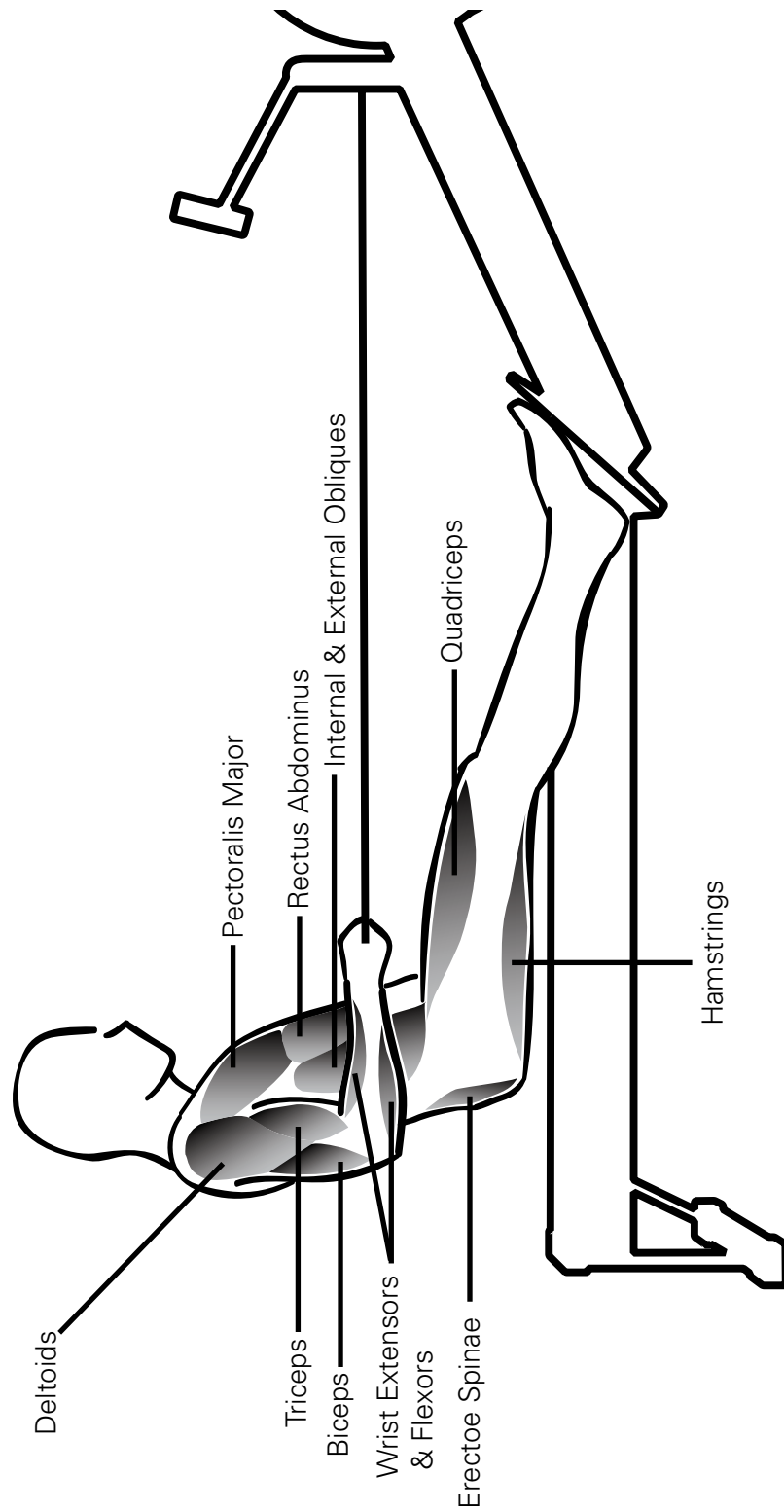

# Muscle Groups 3 - Finish

---

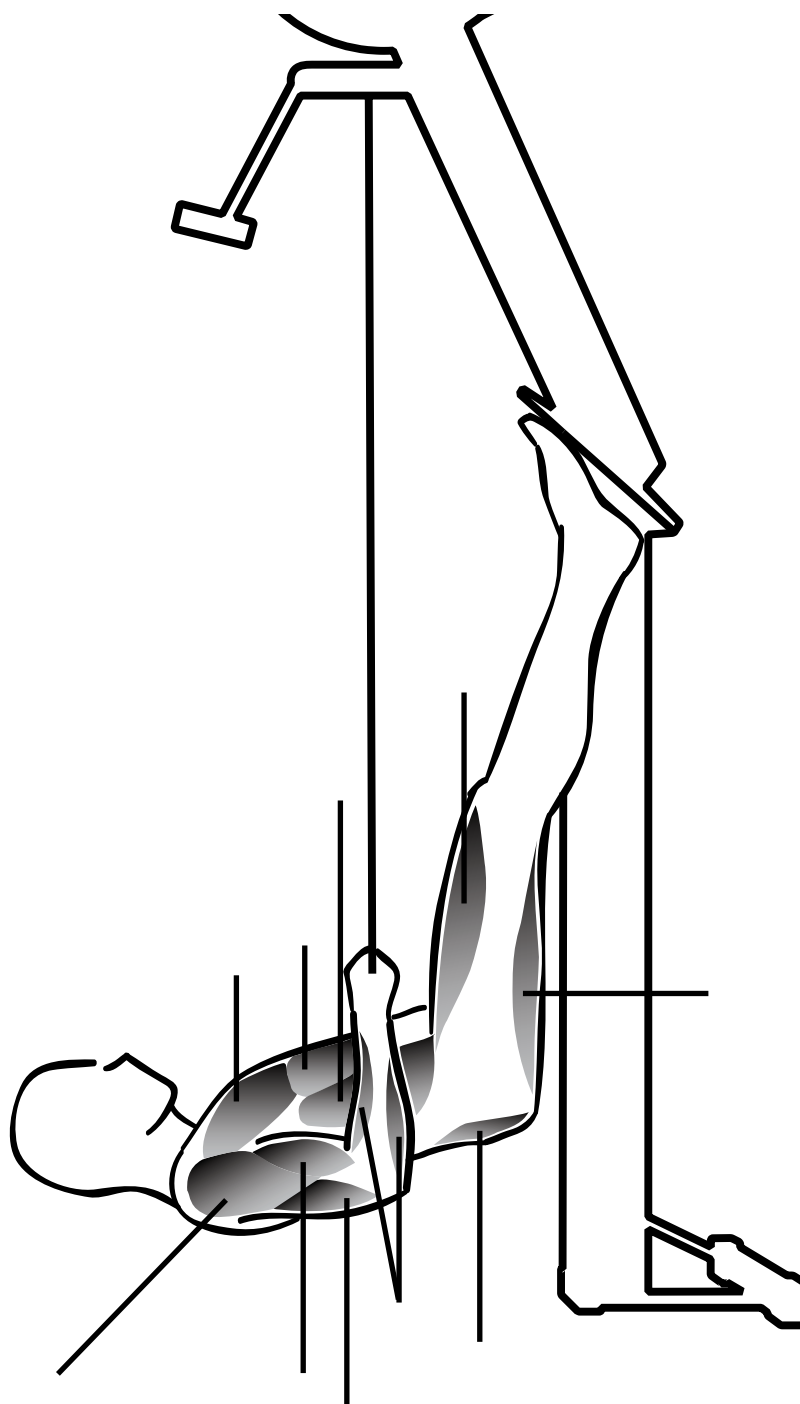

# Muscle Groups 4 - Recovery

---

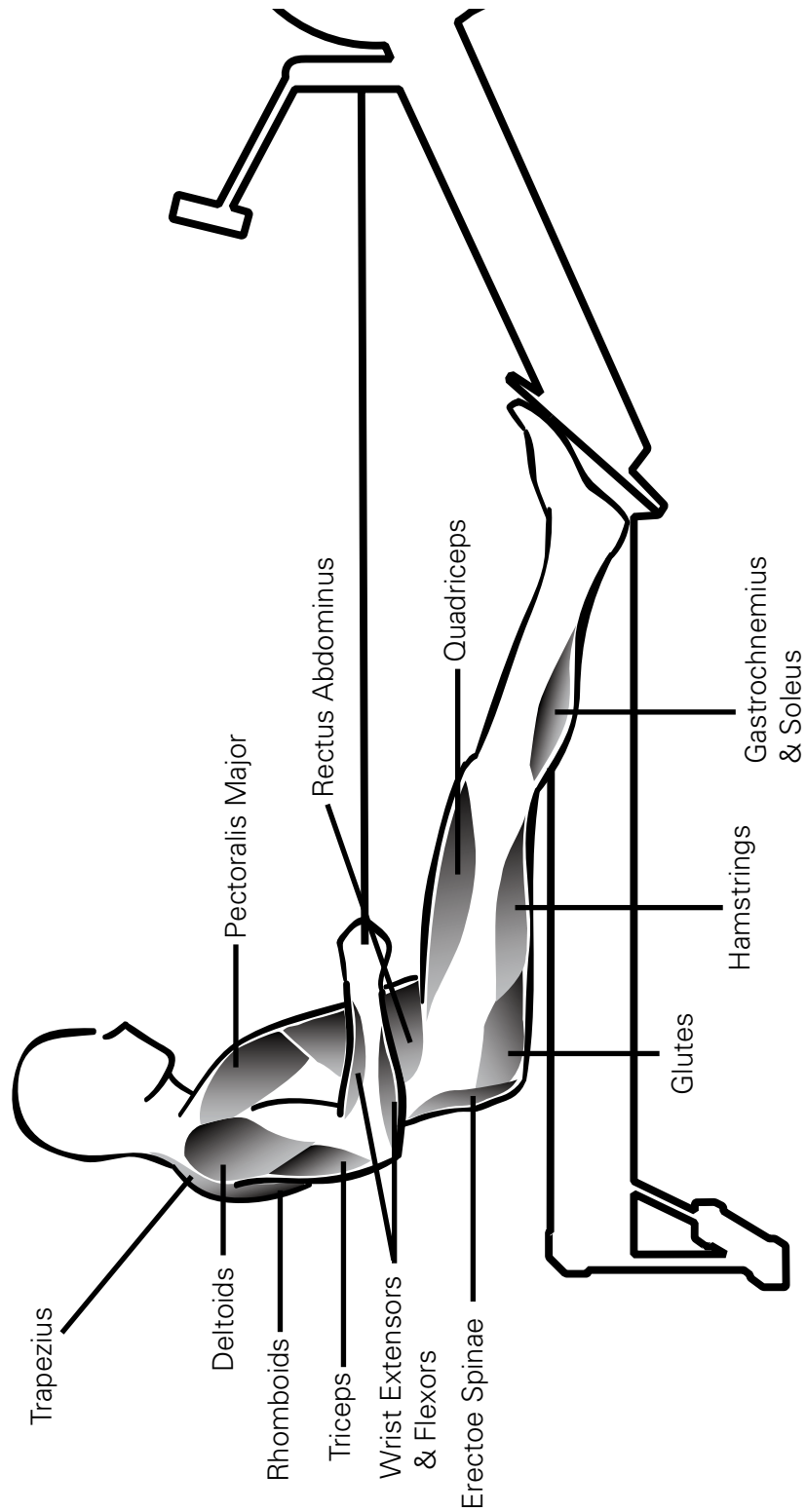



# Muscle Groups 4 - Recovery

---

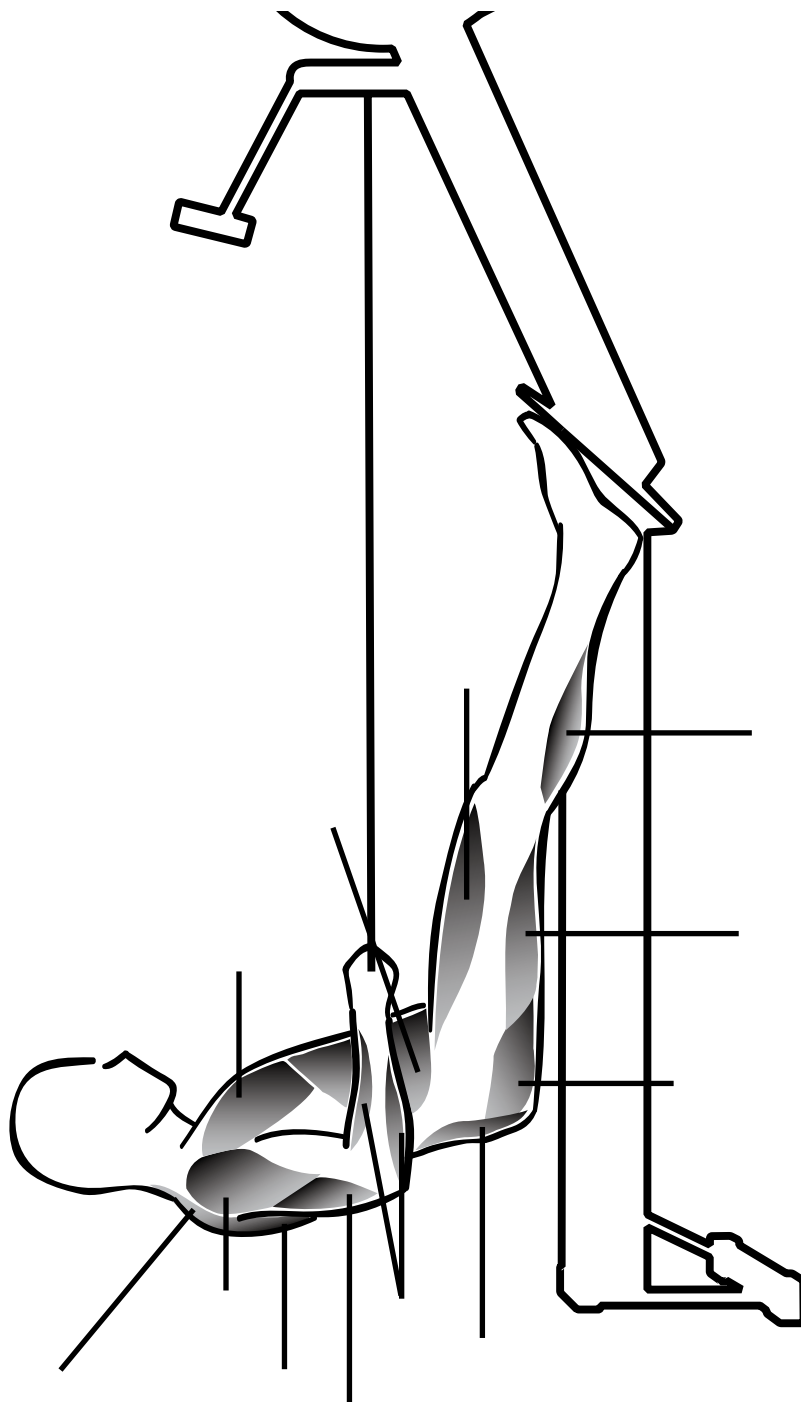

# Anatomy of an Indoor Rower

---

